



AORM Software Instruction Manual



AORM Software Instruction Manual

© 2013 Teledyne LeCroy, Inc. All rights reserved.

Unauthorized duplication of Teledyne LeCroy documentation materials other than for internal sales and distribution purposes is strictly prohibited. However, clients are encouraged to distribute and duplicate Teledyne LeCroy documentation for their own internal educational purposes.

AORM and Teledyne LeCroy are registered trademarks of Teledyne LeCroy, Inc. Windows is a registered trademark of Microsoft Corporation. Other product or brand names are trademarks or requested trademarks of their respective holders. Information in this publication supersedes all earlier versions. Specifications are subject to change without notice.

923133 Rev A

June 2013

WHAT CAN AORM DO?	7
Histogramming.....	7
Trending.....	7
Model of Optical Recording Processing	7
Selecting Parameters	7
SETUP AND MEASUREMENT DIALOG.....	9
AORM Measurement Menus	11
Measurement Table.....	15
View Menu Selections	16
Equalizer and PLL Dialog	17
CREATING AND ANALYZING HISTOGRAMS.....	18
Selecting the Histogram Function.....	18
Histogram Trace Setup Dialog	18
Setting Binning and Histogram Scale	19
DISPLAYING TRENDS.....	20
Trend Calculation.....	22
Parameter Buffer.....	22
Parameter Events Capture	22
Reading Trends.....	22
MAKING OPTICAL DATA MEASUREMENTS.....	24
View Modes	24
Configuration Options	25
Configuration Menus	26
Setting Levels	28
Setting nT	30
Maximizing Performance	30
Pit or Space Identification.....	31
nT Pit/Space Categorization.....	33
BES BEGINNING EDGE SHIFT.....	34

Description.....	34
Display Options.....	36
BESS BEGINNING EDGE SHIFT SIGMA.....	37
Description.....	37
Display Options.....	38
EES ENDING EDGE SHIFT.....	39
Description.....	39
Display Options.....	41
EESS ENDING EDGE SHIFT SIGMA.....	42
Description.....	42
Display Options.....	43
BEES BEGINNING ENDING EDGE SHIFT.....	44
Description.....	44
Display Options.....	46
DP2C DELTA PIT TO CLOCK.....	47
Description.....	47
Display Options.....	49
DP2CS DELTA PIT TO CLOCK SIGMA.....	50
Description.....	50
Display Options.....	51
EDGSH EDGE SHIFT.....	52
Description.....	52
Display Options.....	52
Example.....	53
More On Edge Shift.....	54
PAA PIT AVERAGE AMPLITUDE.....	56
Description.....	56
Display Options.....	56
Example.....	57

PASYM	PIT ASYMMETRY	58
	Description	58
	Display Options.....	58
	Example	59
PBASE	PIT BASE.....	60
	Description	60
	Display Options.....	60
	Example	61
PMAX	PIT MAXIMUM	62
	Description	62
	Display Options.....	62
	<i>Example:</i>	63
PMIDL	PIT MIDDLE LEVEL	64
	Description	64
	Display Options.....	64
	Example	65
PMIN	PIT MINIMUM.....	66
	Description	66
	Display Options.....	66
	Example	67
PMODA	PIT MODULATION AMPLITUDE.....	68
	Description	68
	Display Options.....	68
PNUM	PIT NUMBER	72
	Description	72
	Display Options.....	72
	Example	73
PRES	PIT RESOLUTION	74
	Description	74
	Display Options.....	74

Example	75
PTOP PIT TOP	77
Description	77
Display Options.....	77
Example	78
PWID PIT WIDTH.....	79
Description	79
Display Options.....	79
Example	80
Example 2: Histogramming.....	80
T@PIT TIME AT PIT	84
Description	84
Example	84
TIMJ TIMING JITTER	90
Description	90
Display Options.....	90
Example	90
More About Timing Jitter	92
SIGNALS, COUPLING, AND THRESHOLD SETTINGS	94
Choice of Signals.....	94
Coupling.....	94
Threshold Selection.....	94
USING PARAMETERS WITH TRENDS AND XY PLOTS	96
Example and Step-by-Step Instructions.....	96
IMPROVING HORIZONTAL MEASUREMENT ACCURACY.....	99
BASE AND TOP CALCULATION DETAILS.....	100
THEORY OF OPERATION.....	103
Teledyne LeCroy DSO Process	103
Parameter Buffer	104
Parameter Events Capture	104

AORM Software Package

Histogram Parameters.....	105
Zoom Traces and Segmented Waveforms.....	106
Histogram Peaks	106
Example	106
Binning and Measurement Accuracy.....	107
DVD PROCESSING MODEL.....	108
DVD RAM	108
FILTERING	110
SLICER.....	110
APPENDIX A: NOTES ON ODATA MATH FUNCTION.....	112
Equalized	112
Operational Notes.....	113
Leveled	114
Extract Clk	114
How the Starting VCO Frequency and Phase are Determined.....	120

BLANK PAGE

WHAT CAN AORM DO?

The Advanced Optical Recording Measurement (AORM) package for Teledyne LeCroy digital oscilloscopes provides a set of waveform measurements and mathematical functions for the analysis of optical recording signals. Parameter measurements allow the categorizing and listing of measurement values in a variety of ways. The math functions (Histogramming and Trending) enable information to be revealed graphically.

The Advanced Optical Recording Measurement package provides parameter measurements for evaluating jitter due to intersymbol interface and emulation of DVD's equalizer, slicer, and PLL. This functionality helps you to perform clock and jitter measurements, independent of a specific Integrated Circuit, allowing you to concentrate on optical head or media performance only. To support advanced optical recording drives that have constant angular velocity (CAV) or zone constant linear velocity (ZCLV), parameter measurements support automatic determination of the clock period.

Histogramming

Histograms can be created for any waveform parameter. They are displayed based on a set of user settings such as bin width or number of parameter events to be used. Histogram parameters are provided for measuring different histogram features such as standard deviation, number of peaks, and most populated bin. Histograms are selected by defining a trace as a math function, and selecting Histogram as the math function. As with other Zoom traces, histograms can be positioned and expanded by using the front panel POSITION and ZOOM knobs.

Trending

The Trend function allows you to create a graph containing successive waveform parameter measurement values. The trend function provides useful visual information on the variation of a waveform parameter within a sector, or even over multiple sectors. The Trend functionality, coupled with other scope features, enables you to graph certain parameters against one another.

Model of Optical Recording Processing

In many applications, it is important to make timing and jitter measurements directly from the RF signal, independent of a specific DVD chip. The optical recording processing function in AORM can perform this processing and can let you view the equalized data, sliced data, threshold, and/or the recovered clock. You can control the cutoff frequency and boost of the equalizing filter, the closed loop bandwidth of the 1st order integrating slicer, and the bandwidth of the phase-locked loop (PLL).

Selecting Parameters

1. Select **Measure** from the menu bar,
2. Touch the **Px** tab for the desired parameter position (P1 to P8).
3. Touch inside the **Measure** field, then select the **Optical Recording** group of parameters:

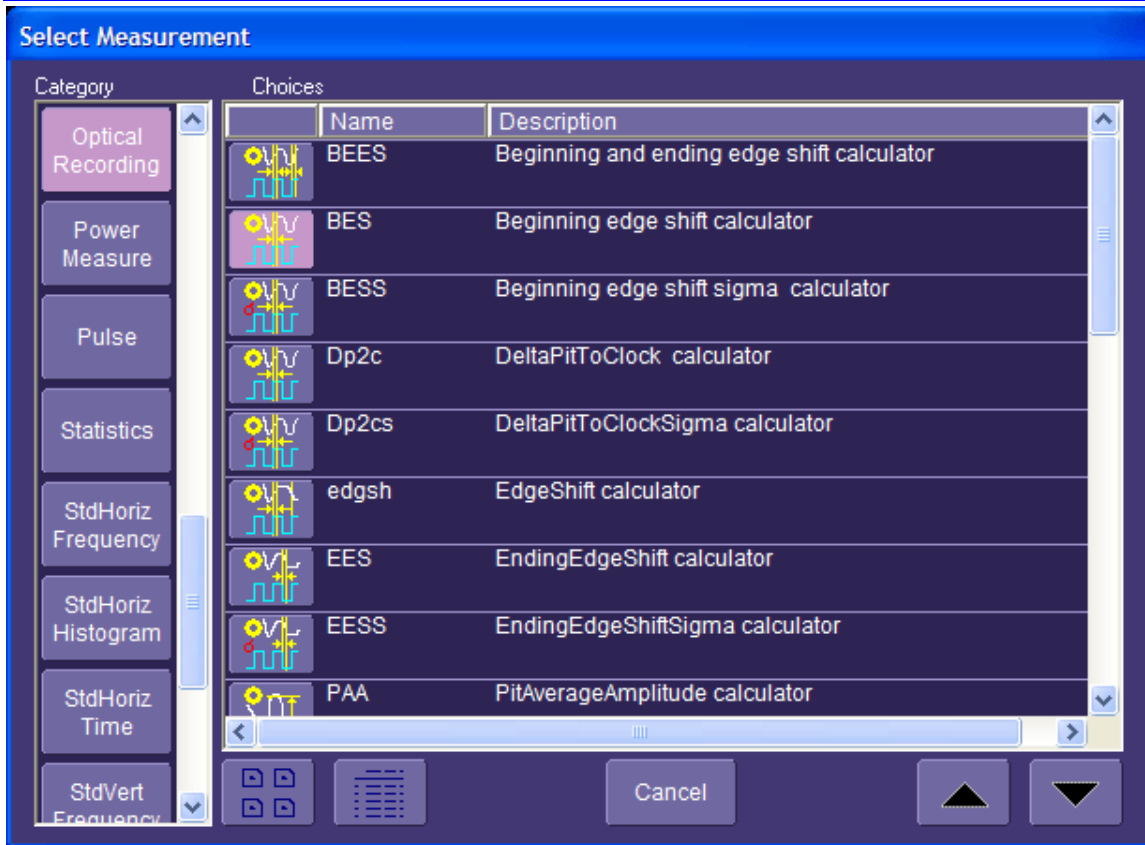

Parameters allow measurements of the section of waveform lying between the parameter cursors. The position of the cursors can be set by dragging, entering an exact value in the **Standard Cursors** dialog, or by means of the **Cursors** front panel knobs. When you enable tracking by checking the Track checkbox, you can move the parameter cursors across the waveform so that measurement results can be taken on different sections of the waveform.

SETUP AND MEASUREMENT DIALOG

The “AORM Measurements” dialog is accessed from the menu bar’s **Analysis** menu. AORM is supplied with X-Stream software version 4.2 and later. This highly interactive dialog allows you to set up and configure the clock and data sources, select a measurement type, and analyze the waveform, including statistics on parametric measurements:

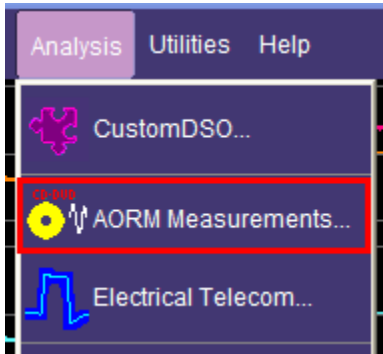



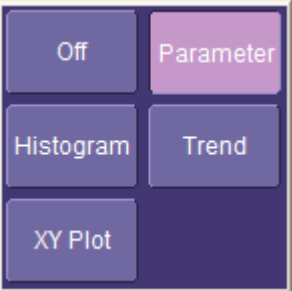
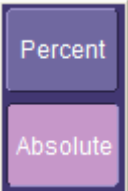

AORM Measurement Menus

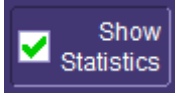
Field	Description
<p>View</p> 	<p>Allows you to quickly select the most common views, with graphing.</p>
<p>Measurement</p> 	<p>Selects the primary measurement to be made. In the Parameter view, the result for the selected measurement is displayed along with other parameters.</p>
<p>Units</p> 	<p>The units used for the horizontal parameter results. Absolute refers to voltage or time units. Percent refers to results being calculated as a percent of the clock period.</p>

Field	Description	
<p>Show</p> 	<p>Determines which table of values is displayed below the grid. When Parameters is selected, a checkbox is displayed that enables you to turn on or off the display of statistics values.</p> 	
<p>Data</p>	<p>Source</p>	<p>This can be a channel, math function, or memory trace. A Use Equalizer checkbox is provided to apply a filter to the data source.</p>
	<p>Data Gate</p>	<p>This can be a channel, math function, memory trace, or other. It specifies the input that will be used to determine where to perform measurements on the input signal. The polarity is always high.</p>
	<p>Use Equalizer</p>	<p>This checkbox enables filtering of the data source.</p>
	<p>Data Slope</p>	<p>Polarity of the pits/spaces to use for the measurement, when appropriate. Pos polarity refers to pits, Neg polarity refers to spaces, Both can be selected to use both pits and spaces.</p>
	<p>Hysteresis</p>	<p>The Hysteresis selection imposes a limit above and below the Threshold, which precludes measurements of noise or other perturbations within this band. The width of the band is specified in divisions.</p> <p>Guidelines for Use</p> <ol style="list-style-type: none"> 1. Hysteresis must be larger than the maximum noise spike you want to ignore. 2. The largest value of hysteresis usable is less than the distance from the threshold to the closest extreme value of the waveform. 3. Unless you know the largest noise and closest extreme level that will ever occur on any cycle, leave some margin on both sides of the threshold.

Field	Description
Clock	<p>The clock need only be specified if the parameter requires a clock for the calculation, or it is used as the source of the period.</p>
	<p>Clock/Period</p> <div style="display: flex; align-items: center;">  <div style="margin-left: 10px;"> <p>By selecting From Data, you can have the clock recovered from the data. In this case, all other clock setup fields except Clock Slope are unavailable.</p> <p>When From Clock is selected, the period is automatically measured from the clock provided. The clock must then be configured.</p> <p>When Period Only is selected,</p> </div> </div>
	<p>Period From</p> <p>Indicates the period of the clock.</p> <p>When a standard is selected, the period is set to the value defined by the standard. You can also set a xN multiplier (e.g., 10x).</p> <div style="text-align: center;">  </div>
	<p>Clock Source</p> <p>This can be a channel, math function, or memory trace.</p>
	<p>Clock Slope</p> <p>Choose Pos, Neg, or Near. “Near” means the nearest clock edge to the data edge.</p>
	<p>Hysteresis</p> <p>Size of the hysteresis band (in screen divisions) with the level at the center of the band. Any waveform being analyzed must pass beyond this band before the next threshold crossing is recognized. The Level may be set to Absolute or Percent.</p>

Field	Description
Subject nT	For BES, EES, BEES, BESS, and EESS, this specifies the pit of interest. The results will be computed for each space/pit (pit/space) pair using the subject pit and all the spaces within the range specified.
Preceded by low nT Preceded by high nT	Specifies the range of n indices that define the pits/spaces used in the calculation. The range of n coupled with T are used to categorize the pits/spaces based on their widths.
From nT To nT	Specifies the range of n indices that define the pits/spaces used in the calculation. The range of n coupled with T is used to categorize the pits/spaces based on their widths.

Measurement Table

When the **Parameter** view is selected, up to 4 additional parameters, which are related to the selected measurement, are displayed. The following table shows these additional parameters. For parameters that can be shown in the XY display, it also shows the parameter that is used for the X axis.

Measurement	Parameters	XY
	<i>(setup for custom parameters)</i>	<i>(x axis)</i>
dp2c (s)	t@pit,pwid,pnum	t@pit
EDGESH	t@pit,pwid,pnum	t@pit
EES (s)	pwid,ptop,pbase,pnum	n/a
BES (s)	pwid,ptop,pbase,pnum	n/a
PAA	pwid,ptop,pbase,pnum	n/a
Pit width	t@pit, ptop,pbase,pnum	t@pit
timj	t@pit, ptop,pbase,pnum	t@pit
Pit base	pwid,ptop,pbase,pnum	pwid
Pit top	pwid,ptop,pbase,pnum	pwid
Pit minimum	pwid,ptop,pbase,pnum	pwid
Pit middle	pwid,ptop,pbase,pnum	pwid
Pit asym	pwid,ptop,pbase,pnum	n/a
Pit max	pwid,ptop,pbase,pnum	pwid
Pit num	pwid,ptop,pbase	n/a

View Menu Selections

View	Displays	Additional Keys
Parameter	The source traces will be displayed along with the custom parameters (see Measurement Table, next). If two traces are to be displayed, dual grids will be drawn.	Statistics: toggles the parameter statistics on/off.
Histogram	When Histogram is selected, a histogram of the selected parameter is displayed in a second grid, and a new tab, "AORM Histogram," appears.	Find Center And Width: determines the best scaling for the histogram based on up to the last 20,000 samples collected. This occurs automatically if the Enable Auto Find checkbox is checked.
Trend	When Trend is selected, a trend plot of the selected parameter is displayed in a second grid, and a new tab, "AORM Trend," appears.	Find Scale: determines the best scaling for the trend (center and height). This occurs automatically if the Auto Find Scale checkbox is checked.
XY Plot	Plots the trend of the selected measurement vs. either the trend t@pit or pwid, as appropriate; not available for all measurements (see Measurement Table, next, for details). When XY Plot is selected, a trend plot of the selected parameter is displayed in a second grid, and a new tab, "AORM Trend Y," appears.	Find Scale: determines the best scaling for trends (center and height). This occurs automatically if the Auto Find Scale checkbox is checked.

Equalizer and PLL Dialog

Field	Description	
Track Clock	Check this checkbox to enable tracking.	
Filter Cutoff and Boost	An equalizer filter is applied prior to the measurements. You can adjust the cutoff frequency and boost of the filter.	
Slicer Bandwidth	The data passes through a slicer to level the data (removes the threshold due to low frequency effects). You can set the bandwidth of the slicer.	
PLL Bandwidth	If you checked the Clock From Data checkbox, a PLL is used to recover the clock from the data waveform. In that case, the bandwidth of the PLL can be adjusted.	
PLL Startup Period From	Auto	When Auto is selected, the startup frequency will be determined by analyzing the peaks of the input signal.
	User	When User is selected, you can set the startup frequency yourself. This is useful when the startup frequency cannot be reliably determined from the input signal.

CREATING AND ANALYZING HISTOGRAMS

Selecting the Histogram Function

Histograms are created by graphing a series of waveform parameter measurements. The first step is to define the waveform parameter to be histogrammed. The next figure shows a screen display accompanying the selection of a frequency (freq) parameter measurement for a sine wave on Channel 1.

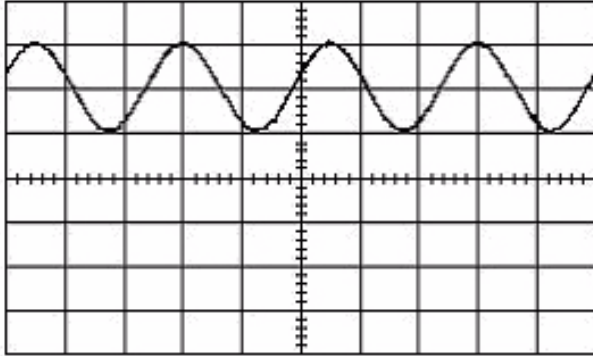

Four waveform cycles are shown, which will provide four freq parameter values for each histogram on each sweep. With a freq parameter selected, a histogram based on it can be specified.

Histogram Trace Setup Dialog

<table border="1"><tr><td>AORM Measurements</td><td>Equalizer and PLL</td><td>AORM Histogram</td></tr><tr><td>#Values 2000</td><td>#Bins 2.00e+3</td><td>Center -4.480e-9</td></tr><tr><td></td><td>Find Center And Width</td><td>Width (/div) 200e-12</td></tr><tr><td></td><td><input checked="" type="checkbox"/> Enable Auto Find</td><td>Vertical Scale Linear</td></tr></table>	AORM Measurements	Equalizer and PLL	AORM Histogram	#Values 2000	#Bins 2.00e+3	Center -4.480e-9		Find Center And Width	Width (/div) 200e-12		<input checked="" type="checkbox"/> Enable Auto Find	Vertical Scale Linear	<p>Each time a waveform parameter value is calculated it can be placed in a histogram bin. Enter the #Bins from 20 to 2000.</p> <p>You can set from 20 to 2 billion parameter value calculations for histogram display in the #Values field.</p>
AORM Measurements	Equalizer and PLL	AORM Histogram											
#Values 2000	#Bins 2.00e+3	Center -4.480e-9											
	Find Center And Width	Width (/div) 200e-12											
	<input checked="" type="checkbox"/> Enable Auto Find	Vertical Scale Linear											
	<table border="1"><tr><td>Center -4.480e-9</td></tr></table>	Center -4.480e-9											
Center -4.480e-9													

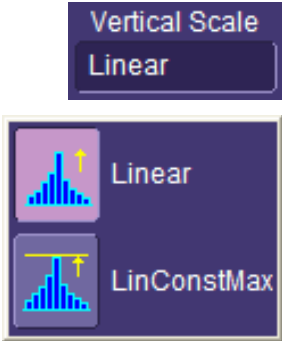
	<p>The current horizontal per division setting for the histogram. The unit type used is determined by the waveform parameter type that the histogram is based on.</p>
	<p>The vertical scale.</p> <ul style="list-style-type: none"> • Linear makes the vertical scale linear. The baseline of the histogram designates a bin value of 0. As the bin counts increase beyond that which can be displayed on screen using the current vertical scale, this scale is automatically increased in a 1-2-5 sequence. • LinConstMax sets the vertical scaling to a linear value that uses close to the full vertical display capability of the scope. The height of the histogram will remain almost constant.

Setting Binning and Histogram Scale

For either the **Linear** or **LinConstantMax** vertical scale option, the scope automatically increases the vertical scale setting as required, ensuring that the highest histogram bin does not exceed the vertical screen display limit.

The **Center** and **Width** fields allow specification of the histogram center value and width per division. The width per division multiplied by the number of horizontal display divisions (10) determines the range of parameter values centered on the number in the **Center** field, used to create the histogram.

DISPLAYING TRENDS

The Trend function for processing waveforms creates a graph of successive waveform parameter values. It provides useful visual information on waveform parameter variation. Used together with other scope features, it allows you to graph certain parameters compared to others.



To Configure a Trend:

1. From the menu bar select **Math**, then **Math Setup...** from the drop-down menu.
2. Touch an **Fx** tab that is not currently assigned a math function (i.e., Zoom function by default).
3. Touch inside the **Source1** field and select a source waveform from the pop-up menu.

4. Touch inside the **Operator1** field and select **Trend**  from the **Select Math Operator** pop-up menu. The "Trend" setup dialog will appear at the right of the screen:



5. Decide whether all the parameter values, all per trace, or only the average of all parameter calculations for each waveform acquisition should be placed in the trend.

All -- every parameter calculation on each waveform will be placed in the trend.

Average -- trends only the average of all the values calculated on a given acquisition and yields one point in the trend per acquisition.

All per Trace -- for each acquisition, clears the buffer and places all parameter calculations from the new data in the trend. Unless this is specifically required, **All** should be selected.

6. Choose the number of values to be placed in the generated trend.
7. If desired, you can also configure the center and height of the trend in the base units of the parameter being trended. However, this is not a requirement, and **Find Scale** can be used to center the trend after it has been calculated.

Center is for selecting the mantissa, exponent, or number of digits resolution, using the associated knob. The configuration is the value at the horizontal center line on the grid, while units are those of the parameter trended.

Height/div selects the vertical value of each vertical screen division. Units are those of the parameter trended.

Trend Calculation

Once the trend has been configured, parameter values will be calculated and trended on each subsequent acquisition. Immediately following an acquisition, its trend values will be calculated. The resulting trend is a waveform of data points that can be used the same way as any other waveform. Parameters can be calculated on it, and it can be zoomed, serve as the x or y trace in an XY plot, and can be used in cursor measurements.

The sequence for acquiring trend data is:

1. trigger
2. waveform acquisition
3. parameter calculations
4. trend update
5. trigger rearm

If the timebase is set in non-segmented mode, a single acquisition occurs prior to parameter calculations. However, in segment mode, an acquisition for each segment occurs prior to parameter calculations. If the source of trend data is a memory, storing new data to memory effectively acts as a trigger and acquisition. Because updating the screen can take significant processing time, it occurs only once a second, minimizing trigger dead time (under remote control the display can be turned off to maximize measurement speed).

Parameter Buffer

The parameter buffer allows you to include up to one million values in the trend calculation.

Parameter Events Capture

The number of events captured per waveform acquisition or display sweep depends on the parameter type. Acquisitions are initiated by the occurrence of a trigger event. Sweeps are equivalent to the waveform captured and displayed on an input channel (1, 2, 3, or 4). For non-segmented waveforms, an acquisition is identical to a sweep. Whereas for segmented waveforms, an acquisition occurs for each segment, and a sweep is equivalent to acquisitions for all segments. Only the section of a waveform between the parameter cursors is used in the calculation of parameter values and corresponding trend events.

Reading Trends

A trend is like any other waveform: its horizontal axis is in units of events, with earlier events in the leftmost part of the waveform and later events to the right. And its vertical axis is in the same units as the trended parameter. When the trend is displayed, trace labels appear in their customary place on the screen identifying the trace, the math function performed, and giving horizontal and vertical information:

- # number of events per horizontal division
- Units per vertical division, in units of the parameter being measured

AORM Software Package

- Vertical value at point in trend at cursor location when using cursors
- Number of events in trend that are within unzoomed horizontal display range.
- Percentage of values lying beyond the unzoomed vertical range when not in cursor measurement mode.

MAKING OPTICAL DATA MEASUREMENTS

View Modes

The two modes available for Optical Recording Measurements, “Custom” and “List by nT,” both display measurements either as waveform parameters or as a list of values. This chapter further describes these modes. The following table indicates which measurements can be made in each mode.

Measurement	Parameter	nT Table
BEES	x	x
BES	x	x
BESS	x	x
Dp2c	x	x
Dp2cs	x	x
EES	x	x
EESS	x	x
EDGSH	x	x
PAA	x	x
Pit asym	x	
Pit base	x	x
Pit max	x	x
Pit middle	x	x
Pit minimum	x	x
Pit moda	x	
Pit number	x	x
Pit res	x	
Pit top	x	x
Pit width	x	x
T@pit	x	
Timj	x	x

Configuration Options

All configuration options are available for each parameter, except as noted in this table:

Parameter	Range of nT	Subject nT
Dp2c	x	
Dp2cs	x	
BEES		x
BES	x	x
BESS	x	x
EES	x	x
EESS	x	x
EDGSH	x	
PAA	x	
Pit asym	x	
Pit base	x	
Pit max	x	
Pit middle	x	
Pit minimum	x	
Pit moda	x	
Pit num	x	
Pit res*	x	
Pit top	x	
Pit width	x	
T@pit*	x	
Timj	x	

* Available from Measure dialog

Configuration Menus

The menus described on the following pages show how to configure any parameter.



Display the AORM dialog by touching **Analysis** in the menu bar at the top of the screen and selecting **AORM Measurements...** from the drop-down menu.



Touch inside the **View** field and select a graph display from the pop-up menu.

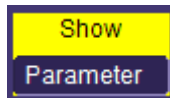
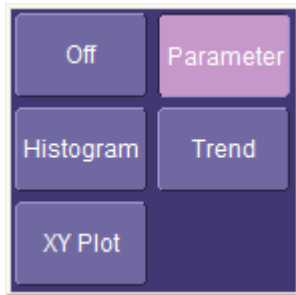

Touch inside the **Show** field and select a display mode. A default group of parameters is automatically displayed when **Parameter** is selected. In addition, if **Show Statistics** is checked, standard statistics (mean, min, max, sdev, num) are also displayed.

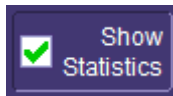

When **nT Table** is selected, a default list of nT is displayed:

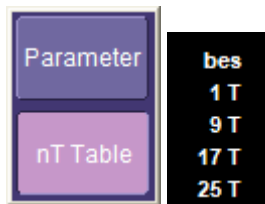



Touch inside the **Measurement** field and select a measurement from the pop-up menu. Besides the parameters included in this menu, others are available from the **Select Measurement menu**, accessible from the **Measure** dialog:

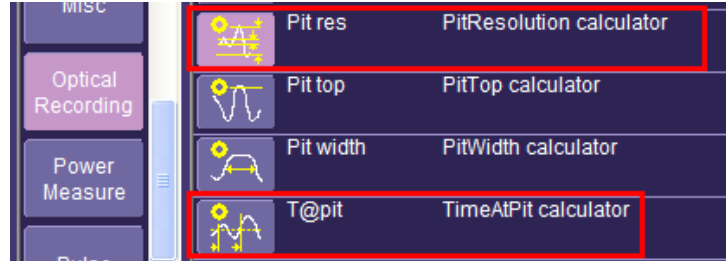

Setting Levels

To identify pits or spaces, thresholds and hysteresis are set.

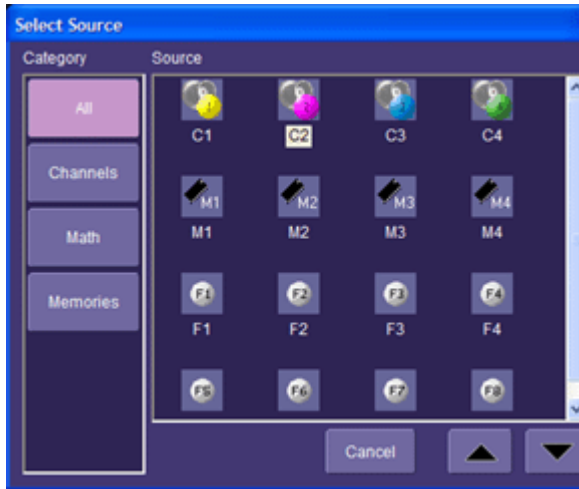

Touch inside the **Data Source** field and select a signal source.

Check **Use Equalizer** to apply a filter to the Data Source.



To set up the equalizer, touch the **Equalizer and PLL** tab.

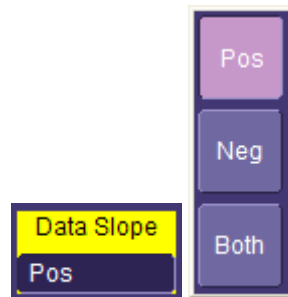

Touch inside the **Data Slope** field and select an edge from the pop-up menu.

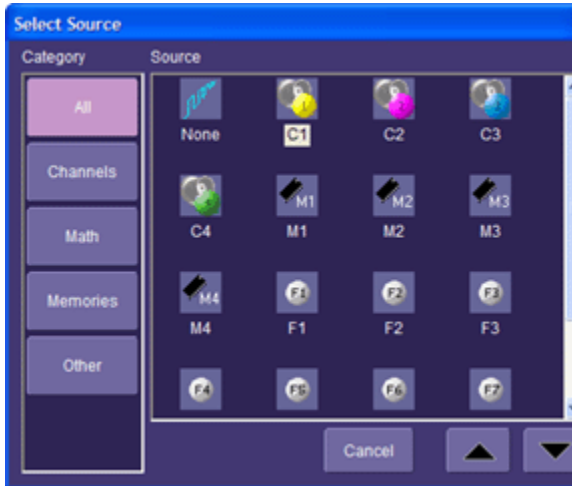

Touch inside the **Data Gate** field and select a signal source. You can also select **None**. Data Gate specifies the input that will be used to determine where to perform measurements on the input signal. If a Data Gate is selected, the level is assumed to be high.

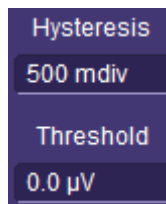

The **Hysteresis** selection imposes a limit above and below the **Threshold**, which precludes measurements of noise or other perturbations within this band. The width of the band is specified in divisions.

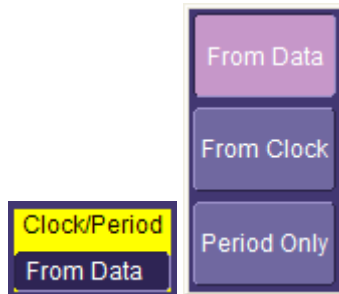

Select **From Data** from the Clock/Period menu if you want to extract the clock from your input waveform. In this case, all other clock setup fields become unavailable except **Clock Slope**. Choose **Pos**, **Neg**, or **Near**. “Near” means the nearest clock edge to the data edge.

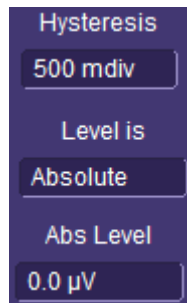

To keep noise out of parametric measurements, set up a hysteresis band, in divisions, about a level. The level can be set to **Absolute** (volts) or **Percent**. In either case, touch inside the **Abs Level** or **Pct Level** field and enter a value, using the pop-up keypad.

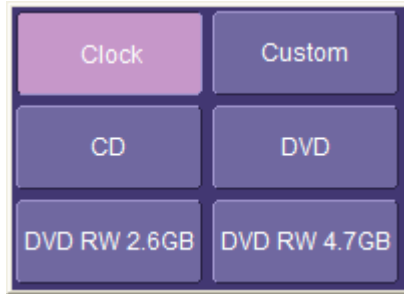

Select a clock period by having the period calculated from the clock source, by choosing a standard, or by manually setting a clock period. If you choose a clock period from a standard, you can also set a multiplier:

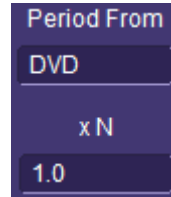

Setting nT

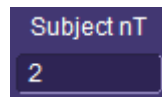

For BES, EES, BEES, BESS, and EESS, this specifies the pit of interest. The results will be computed for each space/pit (pit/space) pair using the subject pit and all the spaces within the range specified.

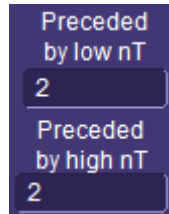

Specifies the range of n indices that define the pits/spaces used in the calculation. The range of n coupled with T are used to categorize the pits/spaces based on their widths.

Maximizing Performance

A basic guideline that you should follow to maximize the performance of calculation in multiple parameter configurations is that precisely the same Value for the clock period 'T', Threshold level, and Hysteresis value should be used.

Following this guideline ensures that parameters can make use of results obtained in previous parameter calculations. However, in most cases there is no need for different configurations of the above three items in different parameter setups.

Pit or Space Identification

This is determined uniquely by the threshold, hysteresis, and edge polarity of threshold crossings. A positive threshold crossing indicates the start of a positive polarity pit and the end of a negative polarity space. A positive threshold crossing followed by a negative threshold crossing fully delineates a pit. A negative crossing followed by a positive crossing fully delineates a space, as illustrated in the following figure.

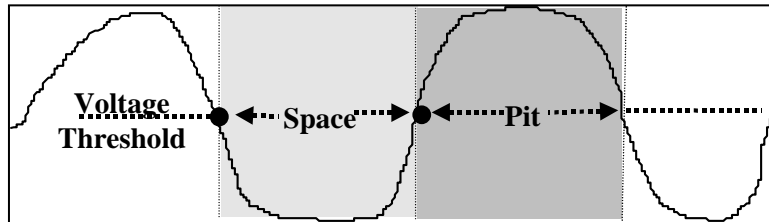

In order to prevent false pit and space identifications, hysteresis is provided. Hysteresis adds an additional condition that must be met before a threshold crossing is recognized as a pit/space edge. It requires that the waveform make an excursion of a certain distance from the threshold before the next threshold crossing is recognized.

The next figure shows a threshold crossing that would result in incorrect pit identification without hysteresis.

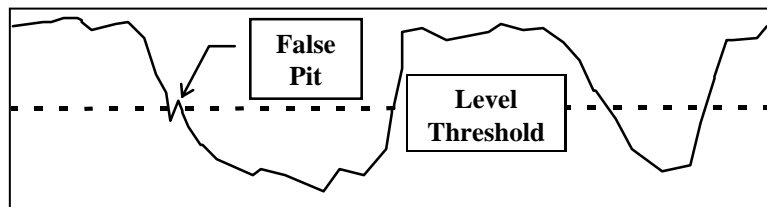

The hysteresis band shown in the next figure is centered on the user-selected voltage level threshold.

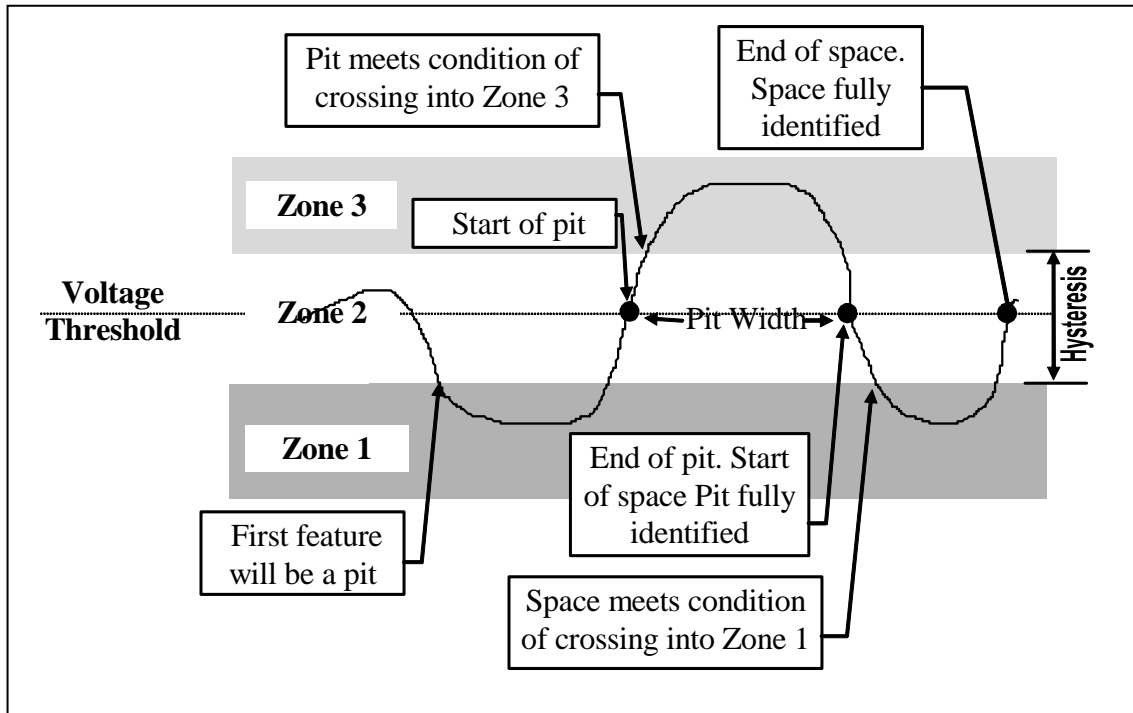

The hysteresis band divides the display into three zones. The ORM Package uses both the voltage threshold and hysteresis settings to identify pits and spaces.

Criteria for identifying a “feature” (pit or space):

- The first feature identified after the left parameter cursor can be either a pit or space. If the signal first enters Zone 1, the first feature identified (if additional constants are met) will be a pit. If the signal first enters Zone 3, it will be a space.
- After first crossing into Zone 1 or Zone 3, the next time the signal crosses the voltage threshold, it is recorded as the start time of a feature.
- If the first feature to be identified is a pit (signal entered Zone 1 first), after crossing the voltage threshold the signal must cross into Zone 3 and then pass the voltage threshold again to complete all conditions for identification as a pit. The first time that the signal crosses the voltage threshold after entering Zone 3 is recorded as the end time of the pit and the start time of the following space. The time between the start and end of the pit is recorded as the pit width. If the first feature to be identified is a space, the signal first entered Zone 3. The algorithm is used with directions reversed.

- For the entire signal, only a space can be identified after a pit, and only a pit can be identified after a space.
- All subsequent features are identified by crossing into the appropriate zone after the end of the previous feature. For a pit this is Zone 3, and for a space it is Zone 1. The end of the previous feature is the beginning of the current feature being identified. The subsequent first time the signal crosses the voltage threshold is recorded as the time of the feature being identified. At this point, the feature has been fully identified.

nT Pit/Space Categorization

Because optical recording data is encoded using a pulse-width modulation mechanism, it is often useful to perform signal analysis for selected pulse widths. Exploiting the fact that optical recording data widths are ideally integral multiples of the data clock period 'T', the AORM Package separates optical recording signal pits and spaces into groups whose widths fall into the same integral multiple of clock periods. As a result, ORMs can be configured to provide values for only pits or spaces, or both of these for a selected 'nT' value ('nT' denotes an integer multiple of the clock period) or for a range of 'nT's.

The ideal clock period (T) is configured on the parameter nT setup.

Categorization of pits and spaces by nT based on width is done using the following equation:

$$(n - 0.5) \cdot T \leq w < (n + 0.5) \cdot T$$

When this condition is met, the pit or space of width w is said to belong to the n^{th} index.

BES BEGINNING EDGE SHIFT

Description

BES provides a measurement of the time between the beginning edge of the subject *n* in a specified space/pit pair and the nearest specified clock edge. The measurement is calculated between the points where the data and clock signals cross selected voltage thresholds. The clock period *T* can be entered by the user, or measured from a user supplied clock signal, as described below.

The value calculated depends on the clock and data edges selected, as shown in the table below. The **data slope** menu selects the polarity of the **subject n** pit/space. If **Pos** (positive) is selected, the measurement is performed from the beginning edges of positive polarity pits and categorized by the preceding space. If **Neg** (negative) is selected, the measurement is performed from the beginning edges of negative polarity spaces and categorized by the preceding pit. If **Both** is selected, the beginning edges of both pits and spaces are used in the calculation and categorized by the preceding inverse polarity space/pit. The sizes of pits or spaces used in the measurement are also determined by the range of 'nT' values chosen.

CLOCK EDGE	DATA SLOPE		
	Pos	Neg	Both
Positive	time between beginning edge of positive polarity subject pit and nearest positive clock edge	time between beginning edge of negative polarity subject space and nearest positive clock edge	time between beginning edge of subject pits and spaces to nearest positive clock edge
Negative	time between beginning edge of positive polarity subject pit and nearest negative clock edge	time between beginning edge of negative polarity subject space and nearest negative clock edge	time between beginning edge of subject pits and spaces to nearest negative clock edge
Near	time between beginning edge of positive polarity subject pit and nearest clock edge	time between beginning edge of negative polarity subject space and nearest clock edge	time between beginning edge of subject pits and spaces and nearest clock edge

The next figure shows the measurement of the beginning edge shift on a single subject 4T pit preceded by a 3T space. In this example, the clock is specified as the positive edge. For each space/pit combination, the beginning edge shift is calculated as the time difference between the beginning pit edge and the clock edge. Additionally, the measurements will be sorted by the space/pit pairs. For the positive polarity pit example shown in the figure after next, measurements t_+ and t_- are for a single beginning edge shift measurement configured for positive edge, or negative edge. If nearest is selected, the smaller of t_- or t_+ is used.

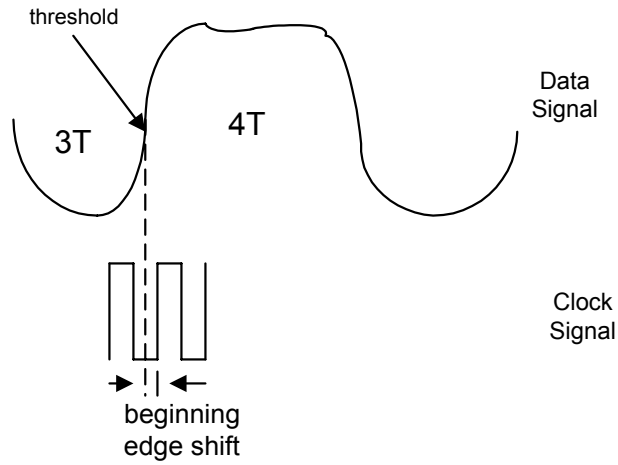

Beginning Edge Shift measurement of subject 4Tpit

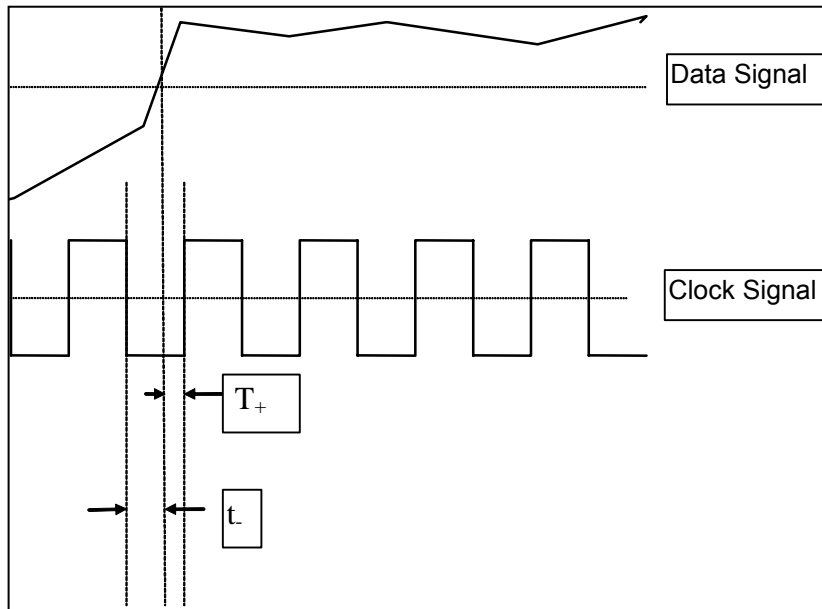

Zoom of Positive Polarity Pit Edge -- example measurement

The measurement has configurable units. If absolute time is specified, the value is simply the time indicated above. If percent is specified, the value of the measurement is the time normalized to the clock period:

For all pits, a valid measurement will be obtained only when both pit/space edges can be determined,

$$bes = \Delta t_+ \cdot \frac{100\%}{T}$$

$$\text{or } \Delta t_- \cdot \frac{100\%}{T}$$

(that is, there is a hysteresis-qualified threshold crossing beginning and ending the pit/space pair of interest between the parameter cursors), and there is a clock edge of both polarities surrounding the leading pit or space edge between the parameter cursors.

Display Options

ORM parameter calculations can be displayed, histogrammed, and trended in a variety of ways.

DISPLAY TYPE	VALUE DISPLAYED
Parameter Statistics Off	All values of the time between beginning edge of the subject <i>n</i> pit (space) and nearest clock edges for all subject pits (spaces) preceded by the spaces (pits) within the selected 'nT' range for the last acquisition.
Parameter Statistics On	Average, minimum, maximum, and sigma of the beginning edge shift calculated for all identified pit/space pairs within the selected 'nT' range for all acquisitions since the last CLEAR SWEEPS operation.
nT Table	List of values of the average beginning edge shift for each 'nT' space (pit) within the selected range preceding the subject pit (space) for the last acquisition.
Histogram Function	Histogram graph of the value of the beginning edge shift calculated for all pit/space pairs within the selected 'nT' range for all acquisitions since the last CLEAR SWEEPS operation.
Trend Function	Trend graph of the value of the beginning edge shift calculated for all pit/space pairs within the selected 'nT' range for all acquisitions since the last CLEAR SWEEPS operation.

BESS BEGINNING EDGE SHIFT SIGMA

Description

BESS provides a measurement of the mean, normalized standard deviation of the Beginning Edge Shift measurements (see **BES**). When a single n is specified, or when you are in 'nT Table' **Show** mode, the value calculated for the n^{th} index is calculated using the following equation for standard deviation:

$$BESS_n = \sigma(BES_n)$$

$$BESS_n = \sqrt{\frac{\sum BES_n^2 - \frac{(\sum BES_n)^2}{N_n}}{N_n - 1}}$$

Beginning Edge Shift Sigma cannot be calculated for a given index n unless there are at least two Beginning Edge Shift values calculated or that n index.

When Beginning Edge Shift is configured as a custom parameter with a range of n , the value calculated is the standard deviation of the distribution that results by normalizing each independent distribution categorized by the space (pit) nT preceding the subject pit (space). Distributions are normalized by subtracting the mean of the distribution from all of the elements in the distribution. This results in the following equation for overall Beginning Edge Shift Sigma resulting from the individually categorized Beginning Edge Shift Sigma values:

$$BESS_{overall} = \sqrt{\frac{\sum (BESS_n^2 \cdot (N_n - 1))}{\sum N_n - 1}}$$

Note: The value calculated by BESS will generally not be the same as the sigma of the BES measurement displayed on the parameter line when a range of n is used and statistics is on. This is because the two measurements are not the same. The BESS measurement normalizes the results for each n by subtracting the mean BES from each BES in the n^{th} distribution. This results in a superposition of mean-centered distributions, not a superposition of 0-centered distributions contributing to BES measurements. BESS will always be less than or equal to the standard deviation of BES measurements.

Display Options

ORM parameter calculations can be displayed, histogrammed and trended in a variety of ways.

DISPLAY TYPE	VALUE DISPLAYED
Parameter Statistics Off	Single value of the standard deviation of the mean normalized beginning edge shift values for pits/spaces of interest for last acquisition.
Parameter Statistics On	Average, minimum, maximum, and sigma of the beginning edge shift sigma value calculated per acquisition for all acquisitions since the last CLEAR SWEEPS operation.
nT Table	List of values of the standard deviation of the beginning edge shift values for each 'nT' spaces (pit) within the selected range preceding the subject pit (space) for the last acquisition.
Histogram Function	Histogram of beginning edge shift sigma values calculated for each acquisition for all acquisitions since the last CLEAR SWEEPS operation.
Trend Function	Trend of the beginning edge shift sigma values calculated for each acquisition for all acquisitions since the last CLEAR SWEEPS operation.

EES ENDING EDGE SHIFT

Description

EES provides a measurement of the time between the ending edge of the subject *n* in a specified space/pit pair and the nearest specified clock edge. The measurement is calculated between the points where the data and clock signals cross selected voltage thresholds. The clock period *T* can be entered by the user or measured from a user supplied clock signal, as described below.

The value calculated depends on the clock and data edges selected, as shown in the table below. The **Data Slope** menu selects the polarity of the **subject n** pit/space. If **Pos** (positive) is selected, the measurement is performed from the ending edges of positive polarity pits and categorized by the following space. If **Neg** (negative) is selected, the measurement is performed from the ending edges of negative polarity spaces and categorized by the following pit. If **Both** is selected, the ending edges of both pits and spaces are used in the calculation and categorized by the following inverse polarity space/pit. The sizes of pits or spaces used in the measurement are also determined by the range of 'nT' values chosen.

CLOCK EDGE	DATA SLOPE		
	Pos	Neg	Both
Positive	time between ending edge of positive polarity subject pit and nearest positive clock edge	time between ending edge of negative polarity subject space and nearest positive clock edge	time between ending edge of subject pits and spaces to nearest positive clock edge
Negative	time between ending edge of positive polarity subject pit and nearest negative clock edge	time between ending edge of negative polarity subject space and nearest negative clock edge	time between ending edge of subject pits and spaces to nearest negative clock edge
Near	time between ending edge of positive polarity subject pit and nearest clock edge	time between ending edge of negative polarity subject space and nearest clock edge	time between ending edge of subject pits and spaces and nearest clock edge

The next figure demonstrates the measurement of the ending edge shift on a single subject 4T pit followed by a 3T space. In this example, the clock is specified as the positive edge. For each pit/space combination, the ending edge shift is calculated as the time difference between the ending pit edge and the clock edge. Additionally, the measurements will be sorted by the pit/space pairs. For the positive polarity pit example shown in the figure after next, the measurements *t+*, and *t-* are for a single ending edge shift measurement configured for positive edge, or negative edge. If nearest is selected the smaller of *t-* or *t+* is used.

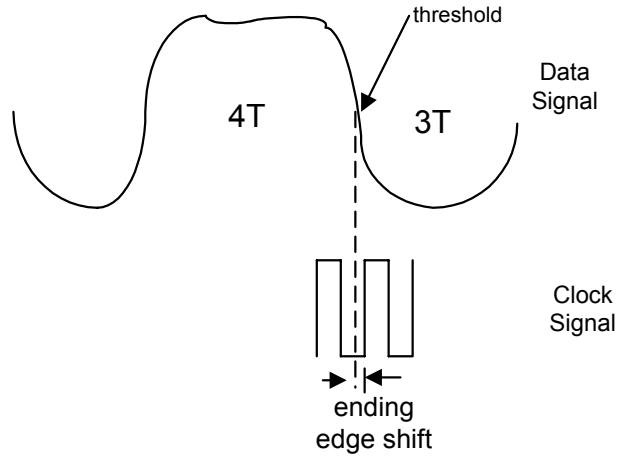

Ending Edge Shift measurement of subject 4T pit

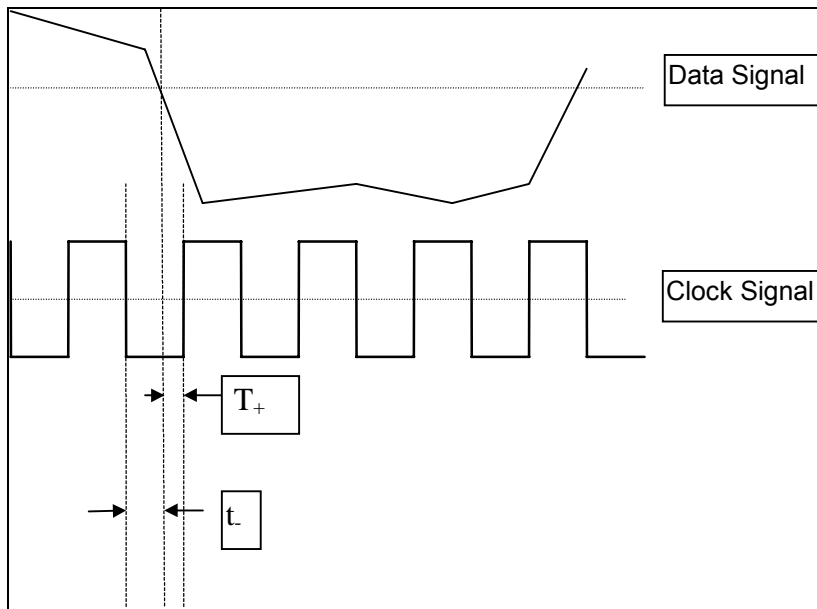

Zoom of Positive Polarity Pit Ending Edge -- example

The measurement has configurable units. If absolute time is specified, the value is simply the time as indicated above. If percent is specified, the value of the measurement is the time normalized to the clock period:

For all pits, a valid measurement will be obtained only when both pit/space edges can be determined

$$ees = \Delta t_+ \cdot \frac{100\%}{T}$$

$$\text{or } \Delta t_- \cdot \frac{100\%}{T}$$

(that is, there is a hysteresis-qualified threshold crossing beginning and ending the pit/space pair of interest between the parameter cursors), and there is a clock edge of both polarities surrounding the ending pit or space edge between the parameter cursors.

Display Options

ORM parameter calculations can be displayed, histogrammed, and trended in a variety of ways.

DISPLAY TYPE	VALUE DISPLAYED
Parameter Statistics Off	All values of the average time between ending edge of the subject <i>n</i> pit (space) and nearest clock edges for all subject pits (spaces) followed by the spaces (pits) within the selected 'nT' range for the last acquisition.
Parameter Statistics On	Average, minimum, maximum, and sigma of the ending edge shift calculated for all identified pits/spaces pairs within the selected 'nT' range for all acquisitions since the last CLEAR SWEEPS operation.
nT Table	List of values of the average ending edge shift for each 'nT' space (pit) within the selected range following the subject pit (space) for the last acquisition.
Histogram Function	Histogram graph of the value of the ending edge shift calculated for all pit/space pairs within the selected 'nT' range for all acquisitions since the last CLEAR SWEEPS operation.
Trend Function	Trend graph of the value of the ending edge shift calculated for all pit/space pairs within the selected 'nT' range for all acquisitions since the last CLEAR SWEEPS operation.

EESS ENDING EDGE SHIFT SIGMA

Description

EESS provides a measurement of the mean, normalized standard deviation of the Ending Edge Shift measurements (see **EES**). When a single n is specified, or when you are in 'nT Table' **Show** mode, the value calculated for the n^{th} index is calculated using the following equation for standard deviation:

$$EESS_n = \sigma(EES_n)$$
$$EESS_n = \sqrt{\frac{\sum EES_n^2 - \frac{(\sum EES_n)^2}{N_n}}{N_n - 1}}$$

Ending Edge Shift Sigma cannot be calculated for a given index n unless there are at least two Ending Edge Shift values calculated for that n index.

When Ending Edge Shift is configured as a custom parameter with a range of n , the value calculated is the standard deviation of the distribution that results by normalizing each independent distribution categorized by the space (pit) nT following the subject pit (space). Distributions are normalized by subtracting the mean of the distribution from all of the elements in the distribution. This results in the following equation for overall Ending Edge Shift Sigma resulting from the individually categorized Ending Edge Shift Sigma values:

$$EESS_{overall} = \sqrt{\frac{\sum (EESS_n^2 \cdot (N_n - 1))}{\sum N_n - 1}}$$

Note: The value calculated by EESS will generally not be the same as the sigma of EES measurement when a range of n is used and statistics are on. This is because the two measurements are not the same. The EESS measurement normalizes the results for each n by subtracting the mean EES from each EES in the n^{th} distribution. This results in a superposition of mean-centered distributions, not a superposition of 0-centered distributions contributing to EES measurements. EESS will always be less than or equal to the standard deviation of EES measurements.

Display Options

ORM parameter calculations can be displayed, histogrammed and trended in a variety of ways.

DISPLAY TYPE	VALUE DISPLAYED
Parameter Statistics Off	Single value of the standard deviation of the mean normalized ending edge shift values for pits/spaces of interest for last acquisition.
Parameter Statistics On	average, minimum, maximum, and sigma of the ending edge shift sigma value calculated per acquisition for all acquisitions since the last CLEAR SWEEPS operation.
nT Table	List of values of the standard deviation of the ending edge shift values for each 'nT' spaces (pit) within the selected range following the subject pit (space) for the last acquisition.
Histogram Function	Histogram of ending edge shift sigma values calculated for each acquisition for all acquisitions since the last CLEAR SWEEPS operation.
Trend Function	Trend of the ending edge shift sigma values calculated for each acquisition for all acquisitions since the last CLEAR SWEEPS operation.

BEES BEGINNING ENDING EDGE SHIFT

Description

BEES provides a measurement of both the beginning and ending edge shift for a subject *n* pit (space) preceded and followed by a specified space (pit). (See **BES** and **EES**.) The measurement is calculated between the points where the data and clock signals cross selected voltage thresholds. The clock period *T* can be entered by the user, or measured from a user supplied clock signal, as described below.

The value calculated depends on the clock and data edges selected, as shown in the table below. The **Data Slope** menu selects the polarity of the **subject n** pit/space. If **Pos** (positive) is selected, the measurement is performed from the beginning and ending edges of positive polarity pits and is preceded and followed by a space of the specified width. If **Neg** (negative) is selected, the measurement is performed from the edges of negative polarity spaces and is preceded and followed by a pit of the specified width.

CLOCK EDGE	DATA SLOPE	
	Pos	Neg
Positive	times between edges of positive polarity subject pit and nearest positive clock edge	times between edges of negative polarity subject space and nearest positive clock edge
Negative	times between edges of positive polarity subject pit and nearest negative clock edge	times between edges of negative polarity subject space and nearest negative clock edge
Near	times between edges of positive polarity subject pit and nearest clock edge	times between edges of negative polarity subject space and nearest clock edge

The next figure demonstrates the measurement of the beginning edge shift on a single subject 4T pit preceded and followed by a 3T space. In this example, the clock is specified as the positive edge. The beginning edge shift is calculated as the time difference between the beginning pit edge and the clock edge while the ending edge shift is calculated as the time difference between the ending pit edge and the clock edge.

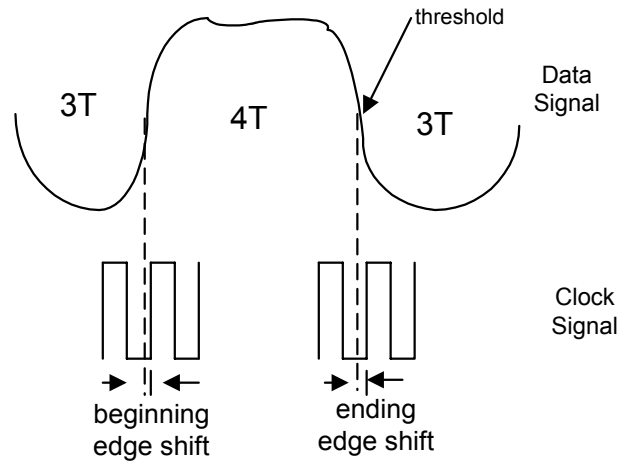

Beginning and Ending Edge Shift measurement of subject 4T pit

The measurement has configurable units. If absolute time is specified, the value is simply the time, as indicated above. If percent is specified, the value of the measurement is the time normalized to the clock period:

$$bees = \Delta t_+ \cdot \frac{100\%}{T}$$

or

$$\Delta t_- \cdot \frac{100\%}{T}$$

For all pits, a valid measurement will be obtained only when both edges of the leading and trailing pits/spaces can be determined (*that is, there is a hysteresis-qualified threshold crossing beginning the start pit/space and ending the end pit/space of interest between the parameter cursors*), and there is a clock edge of both polarities surrounding the leading pit or space edge between the parameter cursors.

Display Options

ORM parameter calculations can be displayed, histogrammed, and trended in a variety of ways.

DISPLAY TYPE	VALUE DISPLAYED
Parameter Statistics Off	Single value of the average time between the edges of the subject <i>n</i> pit (space) and nearest clock edges for all subject pits (spaces) that are preceded and followed by the specified space (pits) for the last acquisition.
Parameter Statistics On	Average, minimum, maximum, and sigma of the beginning and ending edge shift calculated for all subject pits (spaces) that are preceded and followed by the specified space (pits) for all acquisitions since the last CLEAR SWEEPS operation.
nT Table	List of values of the beginning edge shift and the ending edge shift for all subject pits (spaces) that are preceded and followed by the specified space (pits) for the last acquisition.
Histogram Function	Histogram graph of the values of the beginning and ending edge shift calculated for all subject pits (spaces) that are preceded and followed by the specified space (pits) for all acquisitions since the last CLEAR SWEEPS operation.
Trend Function	Trend graph of the value of the beginning and ending edge shift calculated for all subject pits (spaces) that are preceded and followed by the specified space (pits) for all acquisitions since the last CLEAR SWEEPS operation.
XY Plot	XY Plot displays the trend of one parameter vs. another.

DP2C DELTA PIT TO CLOCK

Description

Dp2c provides a measurement of the time between the leading edge of the pit (or spaces of interest) and the nearest specified clock edge. The measurement is calculated between the points where the data and clock signals cross selected voltage thresholds.

The value calculated depends on the clock and data edges selected, as shown in the table below. If in the **Data Slope** menu **Pos** (positive) is selected, the measurement is performed from the leading edges of positive polarity pits. If **Neg** (negative) is selected, the measurement is performed from the leading edges of negative polarity spaces. And if **Both** is selected, the leading edges of both pits and spaces are used in the calculation. The sizes of pits or spaces used in the measurement are also determined by the range of 'nT' values chosen.

CLOCK EDGE	DATA SLOPE		
	Pos	Neg	Both
positive	time between leading edge of positive polarity pit and nearest positive clock edge	time between leading edge of negative polarity space and nearest positive clock edge	time between leading edge of pits and spaces to nearest positive clock edge
negative	time between leading edge of positive polarity pit and nearest negative clock edge	time between leading edge of negative polarity space and nearest negative clock edge	time between leading edge of pits and spaces to nearest negative clock edge
near	time between leading edge of positive polarity pit and nearest clock edge	time between leading edge of negative polarity space and nearest clock edge	time between leading edge of pits and spaces and nearest clock edge

For the positive polarity pit example shown as the zoom of the measurement (next two figures), the measurements t_+ , t_- , t_n are for a single Delta Pit-to-Clock measurement configured for positive edge, negative edge, or nearest edge, respectively.

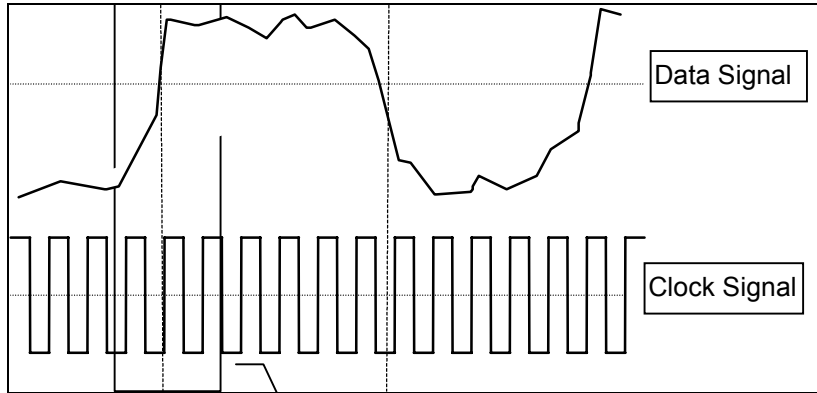

Delta Pit-to-Clock measurement

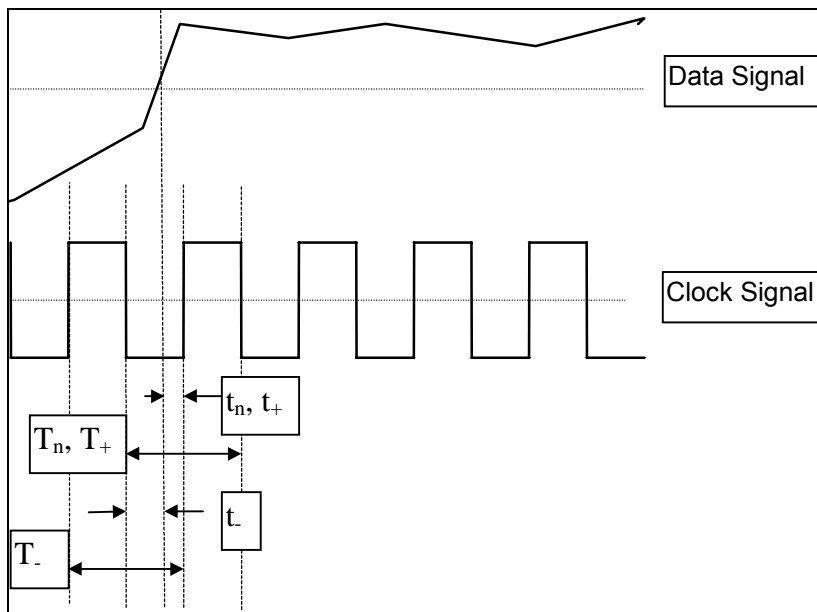

Zoom of Positive Polarity Pit Edge - example measurement

The measurement has configurable units. If absolute time is specified, the value is simply the time as indicated above. If percent is specified, the value of the measurement is the time normalized to the local clock period. The local clock period is calculated as the time between the two clock edges bracketing the clock edge used for the delta time measurement:

$$\Delta p2c = \Delta t_+ \cdot \frac{100\%}{T_+}$$

or $\Delta t_- \cdot \frac{100\%}{T_-}$

or $\Delta t_n \cdot \frac{100\%}{T_n}$

For all pits, a valid measurement will be obtained only when both pit/space edges can be determined (*that is, there is a hysteresis qualified threshold crossing that begins and ends the pit/space of interest between the parameter cursors*), and when there is a clock edge of both polarities surrounding the leading pit or space edge between the parameter cursors.

Display Options

ORM parameter calculations can be displayed, histogrammed and trended in a variety of ways.

DISPLAY TYPE	VALUE DISPLAYED
Parameter Statistics Off	All values of the average time between leading pit/space edges and nearest clock edges for all pits/spaces within the selected 'nT' range for the last acquisition.
Parameter Statistics On	Average, minimum, maximum, and sigma of the Delta Pit-to-Clock calculated for all identified pits/spaces within the selected 'nT' range for all acquisitions since the last CLEAR SWEEPS operation.
nT Table	List of values of the average Delta Pit-to-Clock for each group of pits/spaces of common 'nT' width for the last acquisition.
Histogram Function	Histogram graph of the value of the Delta Pit-to-Clock calculated for all pits/spaces within the selected 'nT' range for all acquisitions since the last CLEAR SWEEPS operation.
Trend Function	Trend graph of the value of the Delta Pit-to-Clock calculated for all pit/space within the selected 'nT' range for all acquisitions since the last CLEAR SWEEPS operation.

DP2CS DELTA PIT TO CLOCK SIGMA

Description

Dp2cs provides a measurement of the mean, normalized standard deviation of the Delta Pit-to-Clock measurements (see **Dp2c**). When a single n is specified, or in 'nT Table' **Show** mode, the value calculated for the n^{th} index is calculated using the following equation for standard deviation:

$$\Delta P2CS_n = \sigma(\Delta P2C_n)$$
$$\Delta P2CS_n = \sqrt{\frac{\sum \Delta P2C_n^2 - \frac{(\sum \Delta P2C_n)^2}{N_n}}{N_n - 1}}$$

Delta Pit-to-Clock Sigma cannot be calculated for a given index n unless there are at least two Delta Pit-to-Clock values calculated for that n index.

When Delta Pit-to-Clock is configured as a custom parameter with a range of n , the value calculated is the standard deviation of the distribution that results by normalizing each independent distribution categorized by nT. Distributions are normalized by subtracting the mean of the distribution from all of the elements in the distribution. This results in the following equation for overall Delta Pit-to-Clock Sigma resulting from the individually categorized Delta Pit-to-Clock Sigma values:

$$\Delta P2CS_{overall} = \sqrt{\frac{\sum (\Delta P2CS_n^2 \cdot (N_n - 1))}{\sum N_n - 1}}$$

Note: The value calculated by DP2CS will generally not be the same as the sigma of DP2C measurement displayed on the parameter line when a range of n is used and statistics is on. This is because the two measurements are not the same. DP2CS measurement normalizes the results for each n by subtracting the mean DP2C from each DP2C in the n^{th} distribution. This results in a superposition of mean centered distributions, not a superposition of 0 centered distributions contributing to DP2C measurements. DP2CS will always be less than or equal to the standard deviation of DP2C measurements.

Display Options

ORM parameter calculations can be displayed, histogrammed, and trended in a variety of ways.

DISPLAY TYPE	VALUE DISPLAYED
Parameter Statistics Off	Single value of the standard deviation of the mean normalized Delta Pit-to-Clock values for pits/spaces of interest for last acquisition.
Parameter Statistics On	Average, minimum, maximum and sigma of the Delta Pit-to-Clock sigma value calculated per acquisition for all acquisitions since the last CLEAR SWEEPS operation.
nT Table	List of values of the standard deviation of the Delta Pit-to-Clock values for each individual 'nT' in the selected range of 'nT' for the last acquisition.
Histogram Function	Histogram of Delta Pit-to-Clock sigma values calculated for each acquisition for all acquisitions since the last CLEAR SWEEPS operation.
Trend Function	Trend of the Delta Pit-to-Clock sigma values calculated for each acquisition for all acquisitions since the last CLEAR SWEEPS operation.

EDGSH EDGE SHIFT

Description

Edge Shift provides a measurement of the difference between the width of pits, spaces, or both, and their ideal widths. These ideal widths are integer multiples of the clock period 'T'. The width of the pit or space is determined by the time between crossings of the selected voltage threshold (see **pwid**).

When a single n is specified for the Edge Shift custom parameter, for each pit-width value calculated, the Edge Shift is calculated as:

$$edgsh_i = (w_i - n_i \cdot T) \text{ when absolute time units are specified}$$

or

$$edgsh_i = (w_i - n_i \cdot T) \cdot \frac{100.0\%}{T} \text{ when percent is specified,}$$

where n_i is the n that makes the width closest to nT (i.e., n is the n category to which the width belongs). Thus:

$$(n_i - 0.5) \cdot T \leq w_i < (n_i + 0.5) \cdot T$$

where T is the configured period. It is very important for this parameter calculation that you enter exactly the ideal T .

For 'nT Table' **Show** mode, or custom mode with one n specified, the value displayed for the n^{th} index is the average of all of the edge shift values calculated that belong to that index:

$$edgsh_n = \left(\frac{\sum w_i}{N_n} - n \cdot T \right) \cdot \frac{100.0\%}{T}$$

Where N_n is the number of pits belonging to the n^{th} index. When edge shift is configured as a custom parameter with a range of n , the overall edge shift is calculated and displayed as the weighted average of the edge shift values calculated above:

$$edgsh_{overall} = \frac{\sum (edsh_n \cdot N_n)}{\sum N_n}$$

The measurement calculation is compliant with the definition of Edge Shift as defined by ISO/IEC JTC1.23.14517 Section 22.4.

Display Options

ORM parameter calculations can be displayed, histogrammed, and trended in a variety of ways.

DISPLAY TYPE	VALUE DISPLAYED
Parameter Statistics Off	All values of the overall edge shift for all pits/spaces within the selected 'nT' range for last acquisition.
Parameter Statistics On	Average, minimum, maximum, and sigma of all edge shift values calculated per acquisition for all acquisitions since the last CLEAR SWEEPS operation.
nT Table	List of values of the overall edge shift for each group of pits/spaces of common 'nT' width for the last acquisition.
Histogram Function	Histogram of the single overall edge shift value calculated for each acquisition for all acquisitions since the last CLEAR SWEEPS operation.
Trend Function	Trend of the single overall Edge Shift value calculated for each acquisition for all acquisitions since the last CLEAR SWEEPS operation.

Example

The example shows the CD data signal measured at the selected voltage threshold containing, in sequence, a 5T pit, 3T space, 3T pit and 4T space. If the clock period 'T' is 231.5 ns, then the 5T and 4T edge shift value is simply the difference between the width calculated and the ideal width (since there is only one pit/space of that 'nT' width), thus:

$$edgsh(4T) = (920 - 4 \cdot 231.5) \cdot \frac{100\%}{231.5} = -2.59\%$$

$$edgsh(5T) = (1160 - 5 \cdot 231.5) \cdot \frac{100\%}{231.5} = +1.08\%$$

The 3T edge shift value is the average difference:

$$edgsh(3T) = \frac{\left((690 - 3 \cdot 231.5) \cdot \frac{100\%}{231.5} \right) + \left((695 - 3 \cdot 231.5) \cdot \frac{100\%}{231.5} \right)}{2} = +0.86\%$$

In an nT Table display, these three values would be shown in the appropriate nT location.

More On Edge Shift

A good approach to understanding the operation of the edge shift parameter with different modes of operation starts by considering the next figure, a histogram of 3T to 5T pit widths.

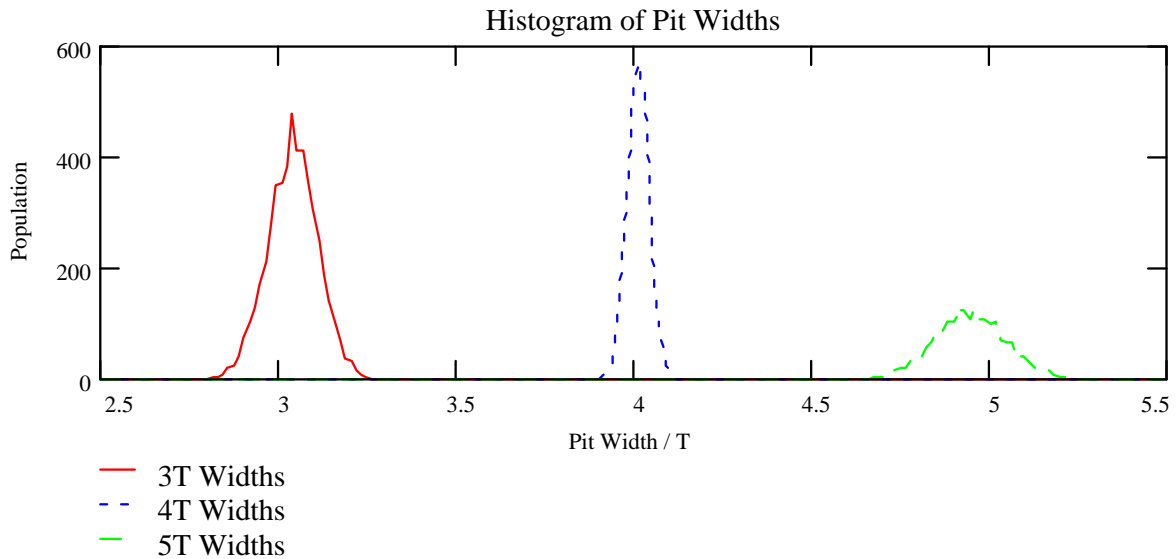
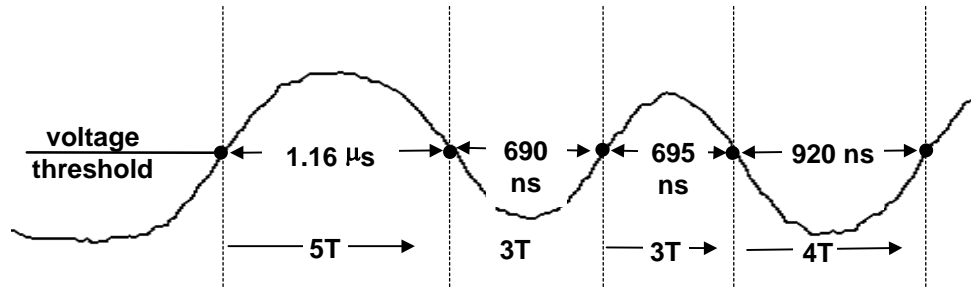

The Edge Shift parameter takes on each of these distributions separately. For each distribution, the ideal width (nT) is subtracted from the pit widths and the difference is calculated in percent. As a result, the Edge Shift distributions are calculated, shown in the next figure.

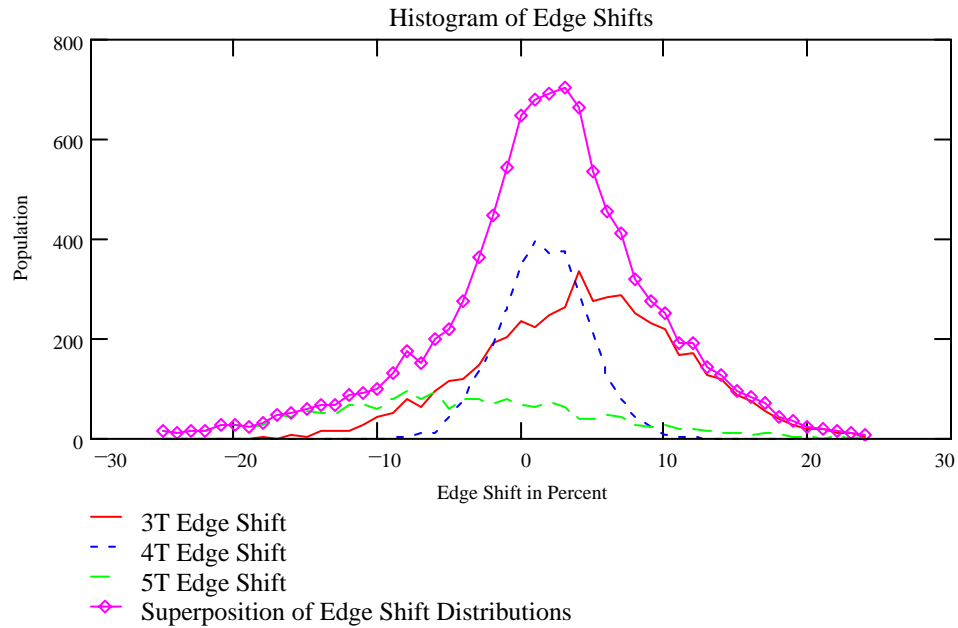

The 3T, 4T, and 5T distributions are obtained when the Edge Shift custom parameter is configured for single n values and histogrammed. The final superposition distribution is obtained when the Edge Shift custom parameter is configured for ranges of n values (in this case 3T to 5T) and histogrammed.

The value displayed on the custom parameter line (with statistics off) is the mean of any of the resulting distributions *for the last acquisition only*. This average edge shift value is calculated internally without actually histogramming the values. The values displayed in 'nT Table' mode are the mean of the Edge Shift distributions resulting from each nT distribution *for the last acquisition*.

Note: The standard deviation of superimposed Edge Shift distributions is not the same as Timing Jitter.

PAA PIT AVERAGE AMPLITUDE

Description

Pit Average Amplitude provides a measurement of the average amplitude of pits and spaces. The calculation is performed by calculating the difference between the average value of the base (pbase) for spaces of a particular 'nT' width and the average value of the top (ptop) of pits of the same 'nT' width. For example, the average value of the base for all 3T spaces is subtracted from the average value of the top for all 3T pits to obtain the 3T pit average amplitude. If a range of 'nT' values is selected and is displayed as a parameter, the measurement provides the weighted average amplitude based on the number of occurrences of each 'nT' pit/space width.

Display Options

ORM parameter calculations can be displayed, histogrammed, and trended in a variety of ways.

DISPLAY TYPE	VALUE DISPLAYED
Parameter Statistics Off	Single value of the average amplitude for all pits/spaces of interest for last acquisition.
Parameter Statistics On	Overall average, minimum, maximum, and sigma of the single average amplitude value calculated per acquisition for all acquisitions since the last CLEAR SWEEPS operation.
nT Table	List of the average amplitude values for each group of pits/spaces of common 'nT' width for the last acquisition.
Histogram Function	Histogram of the single average amplitude value calculated for each acquisition for all acquisitions since the last CLEAR SWEEPS operation.
Trend Function	Trend of the single average amplitude value calculated for each acquisition for all acquisitions since the last CLEAR SWEEPS operation.

Example

Consider this persistence plot of an optical data waveform. Using cursors, the average amplitude of the 3T pits/spaces can be estimated. In this case, the value obtained is 47.2 mV.

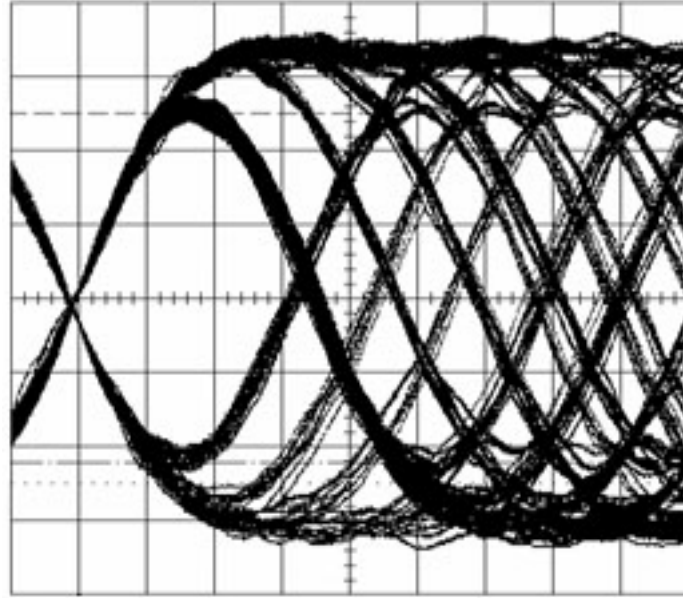

When the parameter **paa** is configured for 3T widths, the measurement result is also 47.2 mV. This value is calculated automatically.

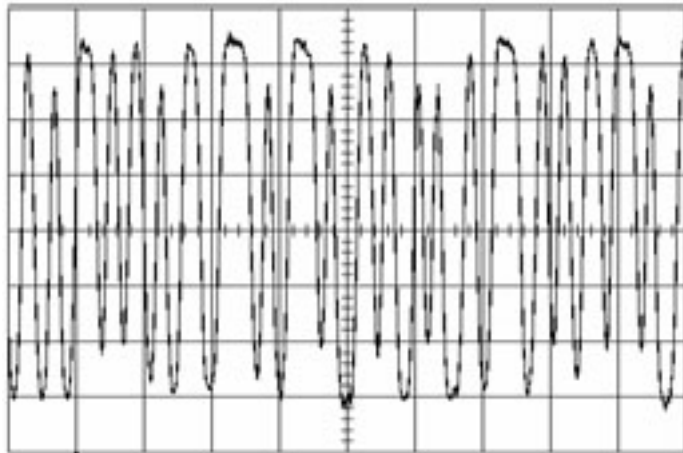

PASYM PIT ASYMMETRY

Description

Pit Asymmetry provides a measurement of the asymmetry of the middle voltage level for the high nT index pits/spaces compared to the middle voltage level of the low 'nT' index pits/spaces. The measurement calculation is compliant with the definition of Pit Asymmetry as defined by IEC 908:1987 Section 3.1. The negative value of the measurement is referred to as Pit Symmetry as defined by ISO/IEC 10149:1995 (E) Section 12.2. Pit Asymmetry is calculated by the formula:

$$PASYM = \frac{pmidl_{high_n} - pmidl_{low_n}}{paa_{high_n}} \cdot 100\%$$

where paa is the average peak-peak amplitude. The low (smallest) and high (largest) 'nT' values to use in performing the calculation are provided by the user through the associated measurement configuration options. Midpoint designates the midpoint value between the average top and base for a specified 'nT.' The value shown is in units of percent.

Display Options

ORM parameter calculations can be displayed, histogrammed, and trended in a variety of ways.

DISPLAY TYPE	VALUE DISPLAYED
Parameter Statistics Off	Single value of the asymmetry for the last acquisition.
Parameter Statistics On	Average, minimum, maximum and sigma of the single asymmetry value calculated per acquisition for all acquisitions since the last CLEAR SWEEPS operation.
Histogram Function	Histogram of asymmetry value calculated per acquisition for all acquisitions since last CLEAR SWEEPS operation.
Trend Function	Trend of single asymmetry value calculated per acquisition for all acquisitions since last CLEAR SWEEPS operation.

Example

This persistence plot of a bandwidth limited, smooth waveform illustrates asymmetry.

Notice that the mid-level of the 3T waveform is offset from 0 V, and that the mid-level of the 11T waveform is approximately 0 V.

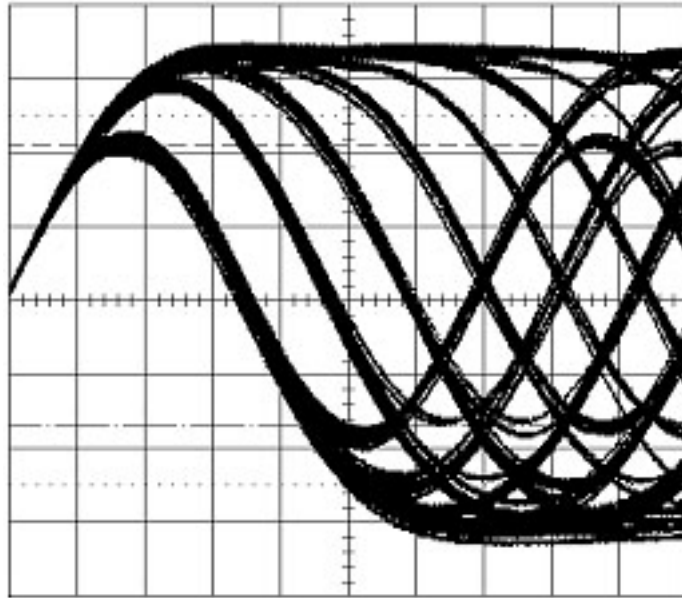

Since the 3T middle level is offset, the expected asymmetry value is negative. This is the asymmetry calculated from a waveform with several thousand widths. The values are the asymmetry, the 3T middle level, the 11T middle level, and the 11T average amplitude.

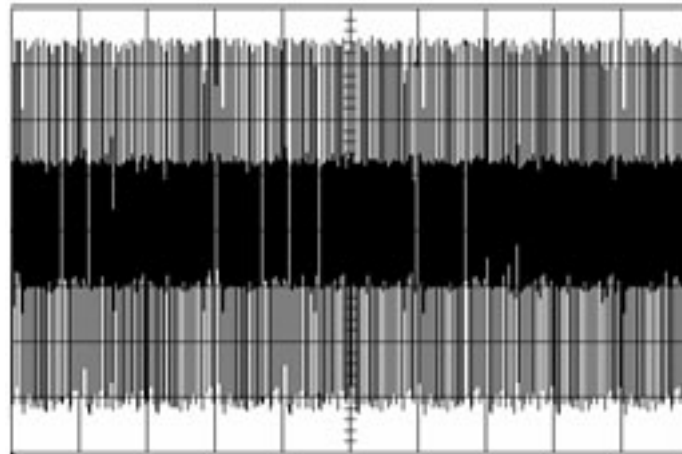

PBASE PIT BASE

Description

Pit Base provides a best estimate of the bottom amplitude of a space. The concept of the base calculation is to automatically provide the same measurement that would be obtained from a persistence plot. The base of each space is determined through histogramming techniques described under *Base and Top Calculation Details*.

When **pbase** is configured as a custom parameter, all bases within the single nT or range of nT are calculated. Histogramming or trending such a configuration would result in one value per space in the nT range contributing a value to the histogram or trend. The value displayed on the custom parameter display line is the average of all such base calculations. 'nT Table' mode provides an average base measurement for each *n* index.

Display Options

ORM parameter calculations can be displayed, histogrammed, and trended in a variety of ways. The following table provides a concise description of the value or values displayed using each approach.

DISPLAY TYPE	VALUE DISPLAYED
Parameter Statistics Off	All values of the base for all spaces within the selected 'nT' range for the last acquisition.
Parameter Statistics On	Average, minimum, maximum, and sigma of the base for all spaces that are within the selected 'nT' range for all acquisitions since the last CLEAR SWEEPS operation.
nT Table	List of values of the average base for each group of spaces of common 'nT' width for the last acquisition.
Histogram Function	Histogram graph of the value of the base for all spaces within the selected 'nT' range for all acquisitions since the last CLEAR SWEEPS operation.
Trend Function	Trend graph of the value of the base calculated for space that is within the selected 'nT' range for all acquisitions since the last CLEAR SWEEPS operation.

Example

This persistence waveform is created by setting a SMART Trigger[®] to capture only 4T spaces. The 4T base computed is -27.0 mV.

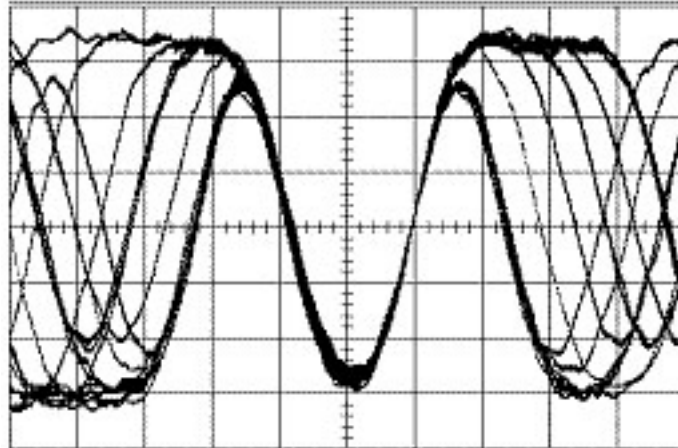

When the same measurement is taken with the parameter cursors, it confirms that -27.0 mV is a reasonable value for the base.

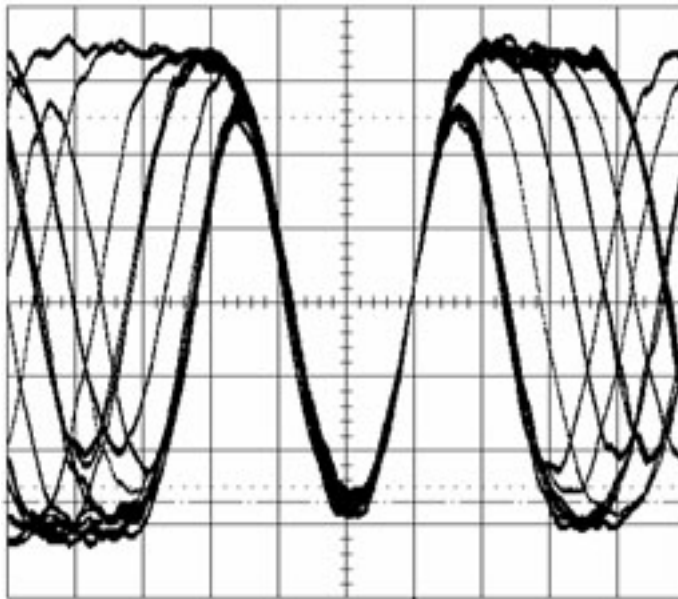

PMAX PIT MAXIMUM

Description

Pit Maximum provides a measurement of the maximum voltage value of pits of interest. It provides a comparison of how the maximum point in the waveform corresponds to the **ptop** value. When **pmax** is configured as a custom parameter, all maximums within the single nT or range of nT are calculated. Histogramming or trending such a configuration would result in one value per pit in the nT range contributing a value to the histogram or trend. The value displayed on the custom parameter display line is the average of all such maximum calculations. 'nT Table' mode provides an average maximum value for the pits in each *n* index.

Display Options

ORM parameter calculations can be displayed, histogrammed and trended in a variety of ways. The table provides a concise description of the value or values displayed using each approach.

DISPLAY TYPE	VALUE DISPLAYED
Parameter Statistics Off	All values of the maximum for all pits within the selected 'nT' range for the last acquisition.
Parameter Statistics On	Average, minimum, maximum, and sigma of the maximum for all pits that are within the selected 'nT' range for all acquisitions since the last CLEAR SWEEPS operation.
nT Table	List of values of the average maximum for each group of pits of common 'nT' width for the last acquisition.
Histogram Function	Histogram graph of the value of the maximum for all pits within the selected 'nT' range for all acquisitions since the last CLEAR SWEEPS operation.
Trend Function	Trend graph of the value of the maximum calculated for each pit that is within the selected 'nT' range for all acquisitions since the last CLEAR SWEEPS operation.

Example:

This waveform contains a single pit, whose max is computed as 26.1 mV.

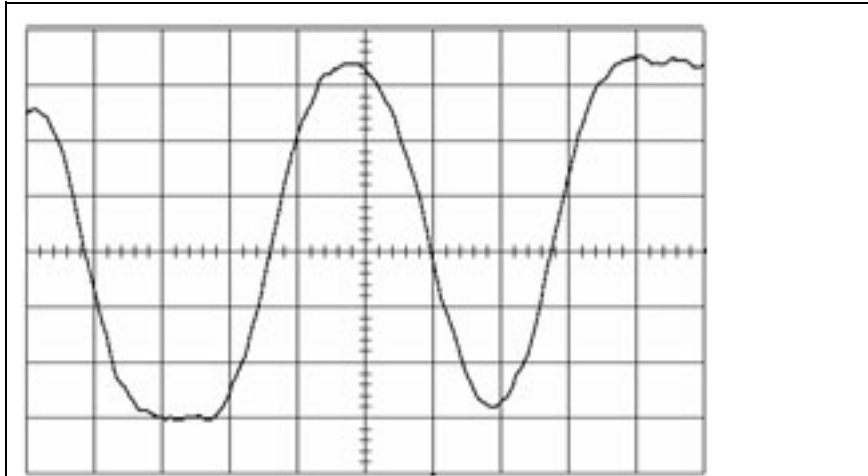

The same measurement is verified using the measurement cursors.

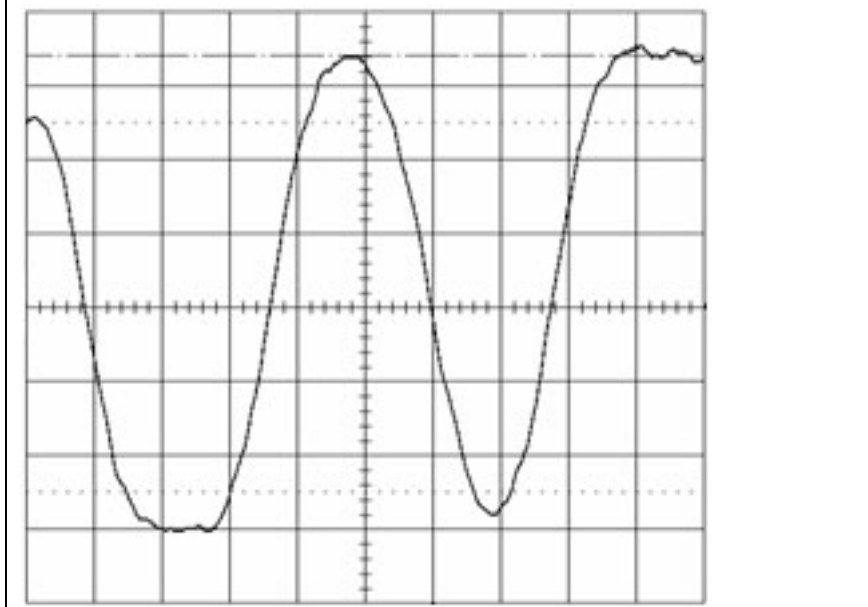

PMIDL PIT MIDDLE LEVEL

Description

Pit Middle Level provides a measurement of the middle voltage level of pits or spaces. It is performed by first calculating the midpoint of the average value of the base (**pbase**) for spaces and the average value of the top of pits (**ptop**). If only 3T pits are specified, the resulting measurement is the 'decision level' (see ISO/IEC 10149:1995 (E) Section 12.1). If a range of 'nT' values is selected and is displayed as a parameter, the measurement provides the weighted average midpoint based on the number of occurrences of each 'nT' pit/space width. The measurement value can be used to determine not only the differences of the midpoint of different 'nT' width pits, but also the overall best data waveform voltage *threshold* setting to use for all ORMs.

Display Options

ORM parameter calculations can be displayed, histogrammed, and trended in a variety of ways.

DISPLAY TYPE	VALUE DISPLAYED
Parameter Statistics Off	Single value of the middle level for all pits/spaces of interest for last acquisition.
Parameter Statistics On	Overall average, minimum, maximum, and sigma of the single middle level value calculated per acquisition, for all acquisitions since the last CLEAR SWEEPS operation.
nT Table	List of the middle level values for each group of pits/spaces of common 'nT' width for the last acquisition.
Histogram Function	Histogram of the single middle level value calculated for each acquisition for all acquisitions since the last CLEAR SWEEPS operation.
Trend Function	Trend of the single middle level value calculated for each acquisition for all acquisitions since the last CLEAR SWEEPS operation.

Example

This waveform contains thousands of pits. In 'nT Table' mode, the middle levels are displayed for each nT index. These values are the midlevels of the tops and bases for pits/spaces within the nT indices.

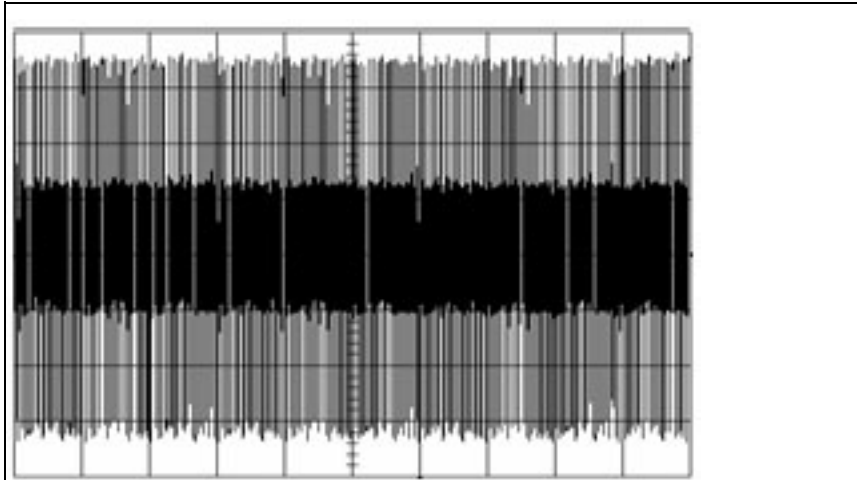

The overall middle level is calculated based on a weighted average of the middle level for each nT. This value is the overall best threshold value for all pits/spaces within the 3T to 11T range.

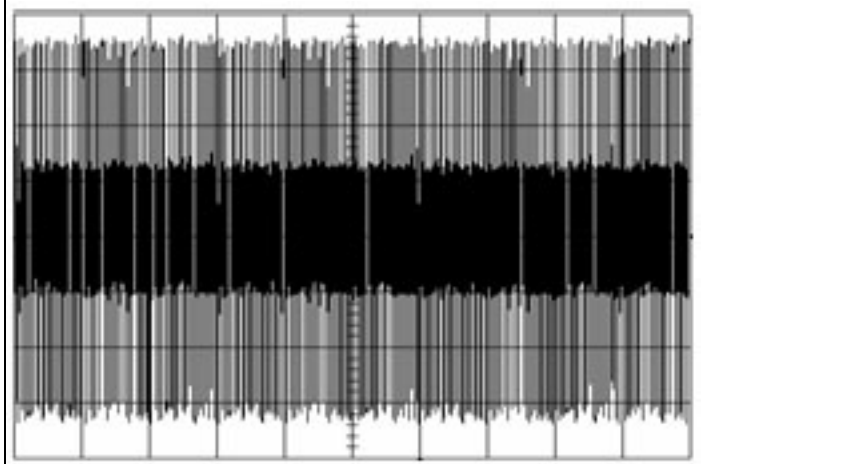

PMIN PIT MINIMUM

Description

Pit Minimum provides a measurement of the minimum voltage value of pits of interest, and a comparison of how the minimum point in the waveform corresponds to the **ptop** value. When **pmin** is configured as a custom parameter, all minimums within the single nT or range of nT are calculated. Histogramming or trending such a configuration would result in one value per pit in the nT range contributing a value to the histogram or trend. The value displayed on the custom parameter display line is the average of all such minimum calculations. 'nT Table' mode provides an average minimum value for the pits in each *n* index.

Display Options

ORM parameter calculations can be displayed, histogrammed, and trended in a variety of ways.

DISPLAY TYPE	VALUE DISPLAYED
Parameter Statistics Off	All values of the minimum for all pits within the selected 'nT' range for the last acquisition.
Parameter Statistics On	Average, minimum, maximum, and sigma of the minimum for all pits that are within the selected 'nT' range for all acquisitions since the last CLEAR SWEEPS operation.
nT Table	List of values of the average minimum for each group of pits of common 'nT' width for the last acquisition.
Histogram Function	Histogram graph of the value of the minimum for all pits within the selected 'nT' range for all acquisitions since the last CLEAR SWEEPS operation.
Trend Function	Trend graph of the value of the minimum calculated for each pit that is within the selected 'nT' range for all acquisitions since the last CLEAR SWEEPS operation.

Example

This waveform contains a single space. The pit min is computed as -9.7 mV.

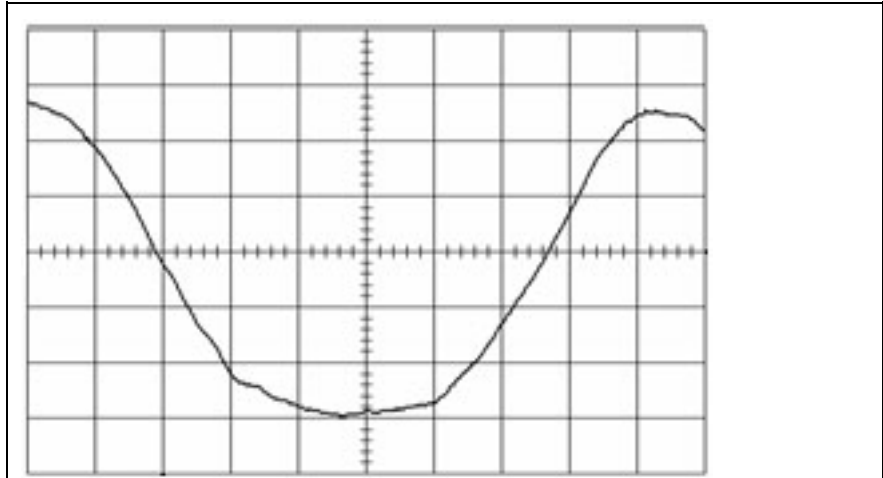

The measurement can be verified with the measurement cursors.

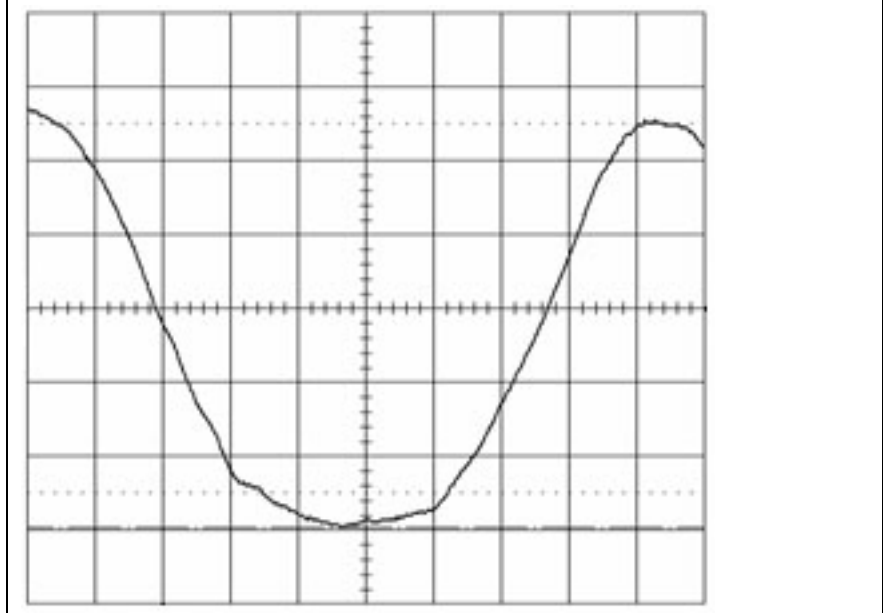

PMODA PIT MODULATION AMPLITUDE

Description

Pit Modulation Amplitude provides a measurement of the ratio of the Pit Average Amplitude (**paa**) for the low 'nT' pits/spaces in the data signal to the Pit Top (**ptop**) of the high 'nT' pits in the data signal:

$$PMODA = \frac{paa_{low_n}}{avg(top)_{high_n}}$$

The *low* and *high* 'nT' values to be used for performing the calculation are provided by the user through the associated measurement configuration options. Some measurements of modulation amplitude require the low and high *n* index to be identical. The value is shown is decimal. The measurement calculation is compliant with the definition of Modulation Amplitude as defined by IEC 908:1987 Section 9.2 and ISO/IEC 10149:1995 (E) Section 12.2.

Note: This measurement must be performed on the DC-coupled optical data waveform, otherwise incorrect values will result.

Display Options

ORM parameter calculations can be displayed, histogrammed, and trended in a variety of ways.

DISPLAY TYPE	VALUE DISPLAYED
Parameter Statistics Off	Single value of the modulation amplitude for the last acquisition.
Parameter Statistics On	Average, minimum, maximum, and sigma of the single modulation amplitude value calculated per acquisition for all acquisitions since the last CLEAR SWEEPS operation.
Histogram Function	Histogram of the modulation amplitude value calculated per acquisition for all acquisitions since the last CLEAR SWEEPS operation.
Trend Function	Trend of the single modulation amplitude value calculated per acquisition for all acquisitions since the last CLEAR SWEEPS operation.

Example

The following persistence plots were generated using the DC-coupled signal.

In the first plot, the amplitude measurement cursor is reading the 11T top voltage of 76.7 mV

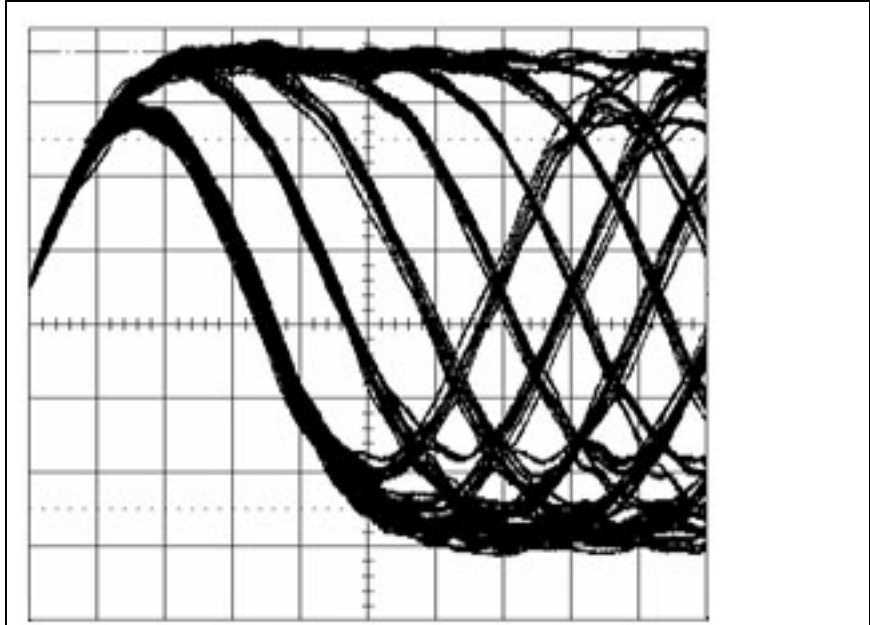

In the second, the cursor reads the difference between the 11T top and base of 67.2 mV.

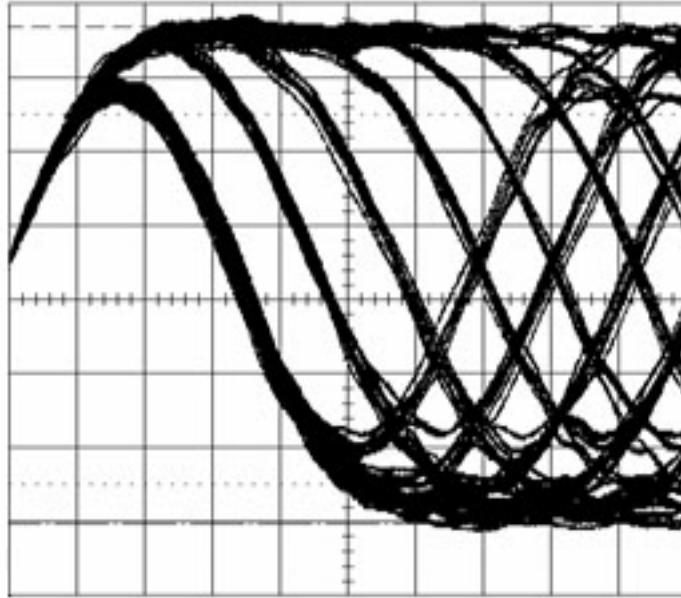

In the third plot, the cursor reads the difference between the 3T top and base of 47.2 mV.

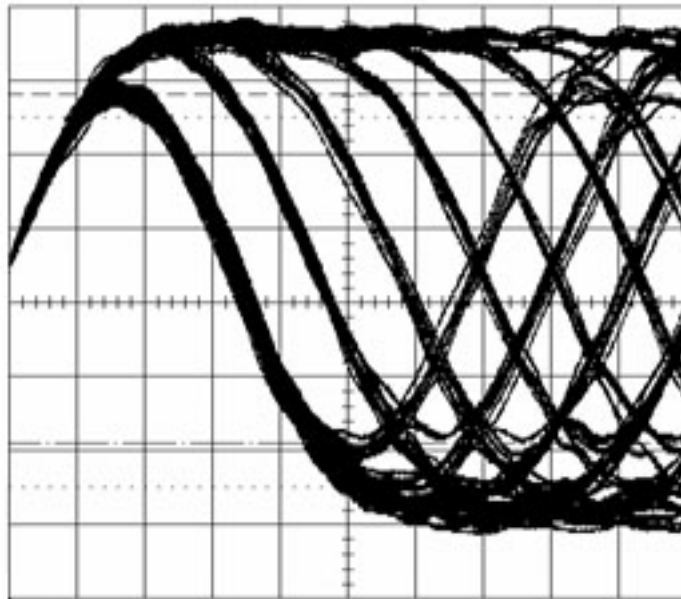

The last plot shows the waveform with the parameters calculated automatically.

1. $p_{moda} 3T p_{aa}/11T top$
2. $p_{moda} 11T p_{aa}/11T top$
3. $p_{aa} 3T$
4. $p_{aa} 11T$
5. $top 11T$

P1 contains the ratio of P3 to P5. P2 contains the ratio of P4 to P5.

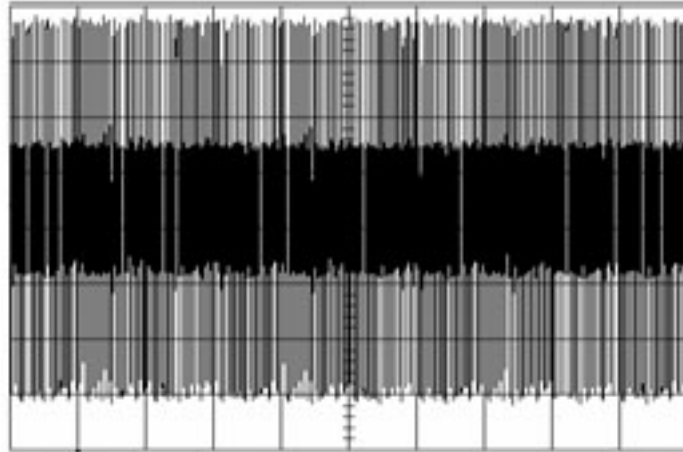

PNUM PIT NUMBER

Description

Pit Number provides a measurement of the number of pits or spaces of interest or both. When **pnum** is selected as a parameter measurement the total number of pits and/or spaces for the selected 'nT' range is displayed. In the nT Table mode the number for each 'nT' value is displayed.

Display Options

ORM parameter calculations can be displayed, histogrammed, and trended in a variety of ways. The table provides a concise description of the value or values displayed using each approach.

DISPLAY TYPE	VALUE DISPLAYED
Parameter Statistics Off	Single value of the total number of pits/spaces within the selected 'nT' range for the last acquisition.
Parameter Statistics On	Average, minimum, maximum, and sigma of the single value of the total number of pits/spaces within the selected 'nT' range, calculated per acquisition for all acquisitions since the last CLEAR SWEEPS operation.
nT Table	List of values of the number pits/spaces for each individual 'nT' in the selected range of 'nT' for the last acquisition.
Histogram Function	Histogram graph of the single value of the number of pits/spaces within the selected 'nT' range calculated each acquisition for all acquisitions since the last CLEAR SWEEPS operation.
Trend Function	Trend graph of the single value of the number of pits/spaces within the selected 'nT' range calculated each acquisition for all acquisitions since the last CLEAR SWEEPS operation.

Example

In this waveform, each of the 3 pits/spaces is easily identified. There is a 4T pit, a 6T space, and a 5T pit. Each is counted and displayed in 'nT Table' mode.

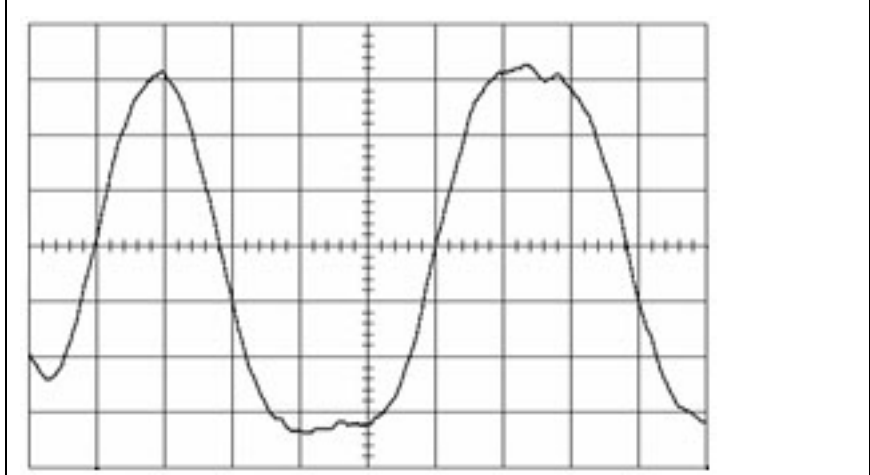

This is the long waveform showing the number of pits/spaces obtained: approximately 9,000.

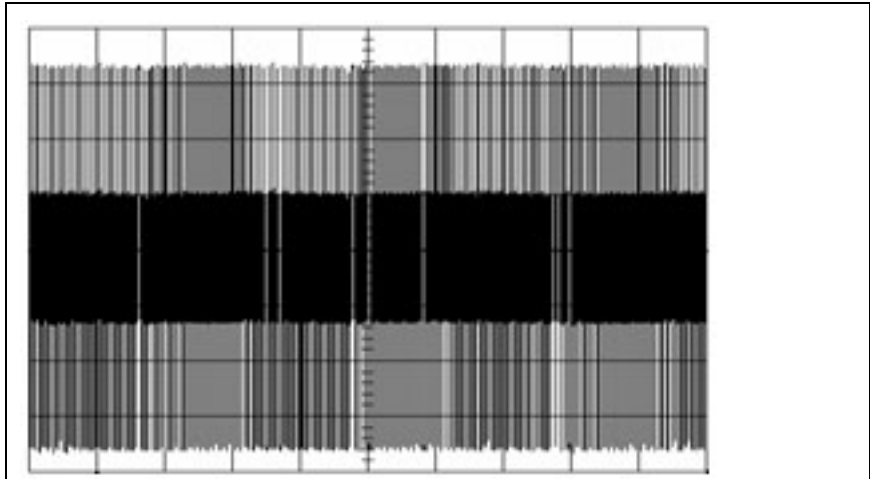

PRES PIT RESOLUTION

Description

Pit Resolution measures the ratio of the Pit Average Amplitude (see **paa** measurement description) of the smallest of the 'nT' pits or spaces in the data signal to that of the largest:

$$PRES = \frac{paa_{low_n}}{paa_{high_n}} \cdot 100\%$$

The *low* and *high* 'nT' values for performing the calculation must be provided by the user through the associated measurement configuration options. The value shown is in units of percent. The measurement calculation is compliant with the definition of Pit Resolution as defined by IEC 13549:1993 Section 15.3.1.

Display Options

ORM parameter calculations can be displayed, histogrammed, and trended in a variety of ways. The table provides a concise description of the value or values displayed using each approach.

DISPLAY TYPE	VALUE DISPLAYED
Parameter Statistics Off	Single value of the pit resolution for the last acquisition.
Parameter Statistics On	Overall average, minimum, maximum, and sigma of the single pit resolution value calculated per acquisition for all acquisitions since the last CLEAR SWEEPS operation.
Histogram Function	Histogram of the single pit resolution value calculated per acquisition for all acquisitions since the last CLEAR SWEEPS operation.
Trend Function	Trend of the single pit resolution value calculated per acquisition for all acquisitions since the last CLEAR SWEEPS operation.

Example

Consider the following persistence plots. In the first, the amplitude measurement cursor reads the difference between the 3T top and base: 47.3 mV.

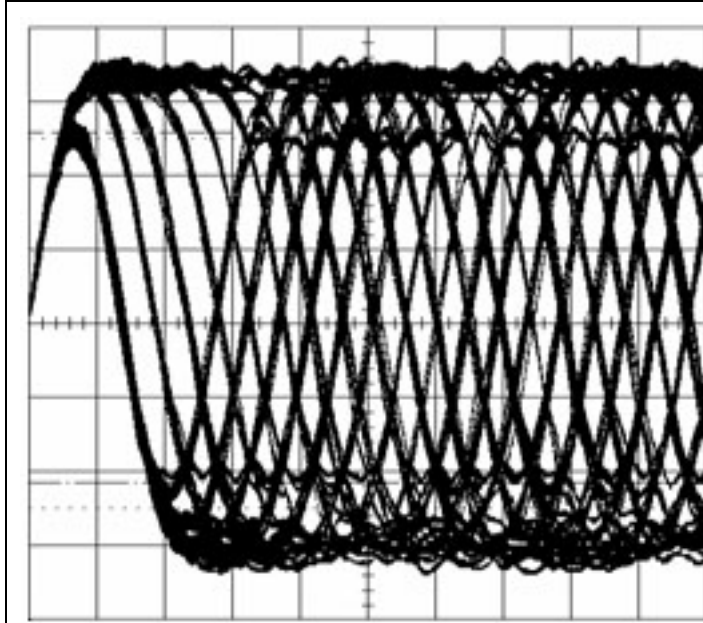

In the second, the cursor reads the difference between the 11T top and base: 67.3 mV.

Therefore, the resolution is:

$$\frac{47.3}{67.3} \cdot 100\% = 70.3\%$$

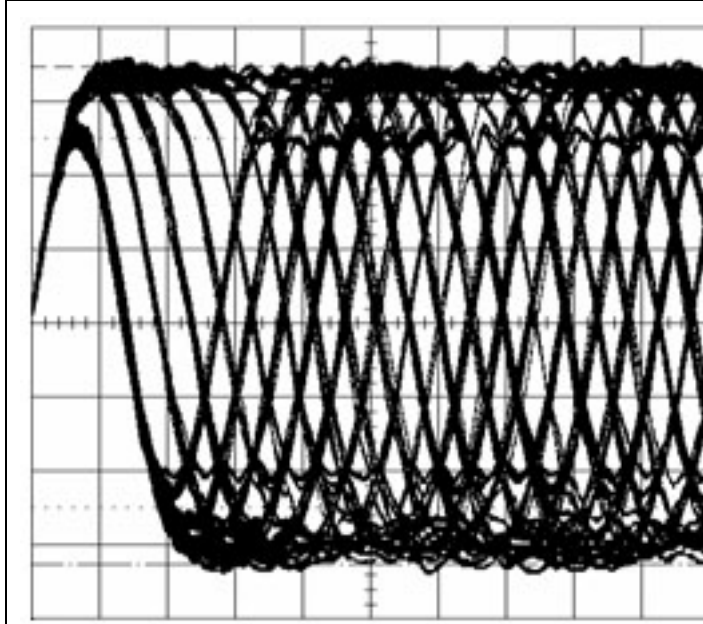

This is the same waveform with the parameters calculated automatically.

1. *pres 3T paa / 11T paa*
2. *paa 3T*
3. *paa 11T*

P1 contains the ratio of P2 to P3 in percent.

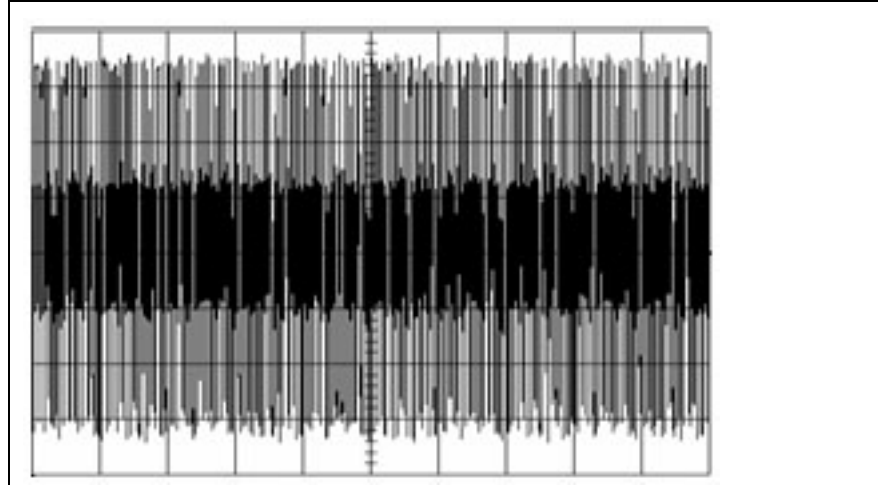

PTOP PIT TOP

Description

Pit Top provides a measurement of the best estimate of the top amplitude of a pit. The concept of the top calculation is to automatically provide the same measurement which would be obtained from a persistence plot. The top of each pit is determined through histogramming techniques described in detail under *Base and Top Calculation Details*. When **ptop** is configured as a custom parameter, all tops within the single nT or range of nT are calculated. Histogramming or trending such a configuration would result in one value per pit in the nT range contributing a value to the histogram or trend. The value displayed on the custom parameter display line is the average of all such top calculations. 'nT Table' mode provides an average top measurement for each *n* index.

Display Options

ORM parameter calculations can be displayed, histogrammed, and trended in a variety of ways.

DISPLAY TYPE	VALUE DISPLAYED
Parameter Statistics Off	All values of the top for all pits within the selected 'nT' range for the last acquisition.
Parameter Statistics On	Average, minimum, maximum, and sigma of the top for all pits within the selected 'nT' range for all acquisitions since last CLEAR SWEEPS operation.
nT Table	List of values of the average top for each group of pits of common 'nT' width for the last acquisition.
Histogram Function	Histogram graph of the value of the top for all pits within the selected 'nT' range for all acquisitions since the last CLEAR SWEEPS operation.
Trend Function	Trend graph of the value of the top calculated for pit that is within the selected 'nT' range for all acquisitions since last CLEAR SWEEPS operation.

Example

This persistence waveform was created by setting a SMART Trigger to capture only 3T pits. The computed 3T top is 25.8 mV.

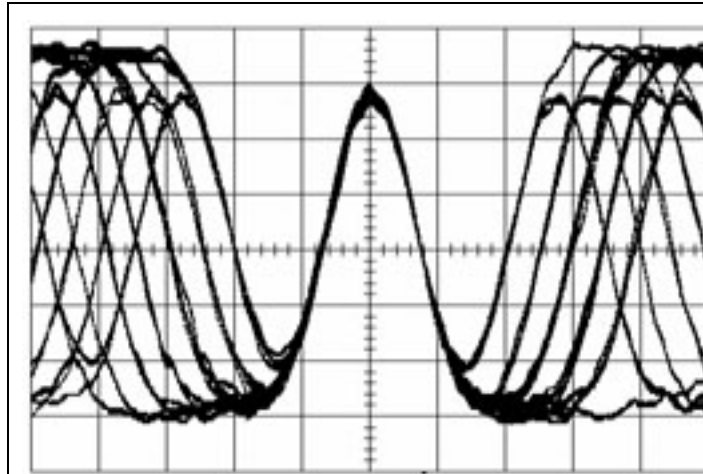

When the same measurement is taken with the parameter cursors, it confirms that 25.8 mV is a reasonable value for the top.

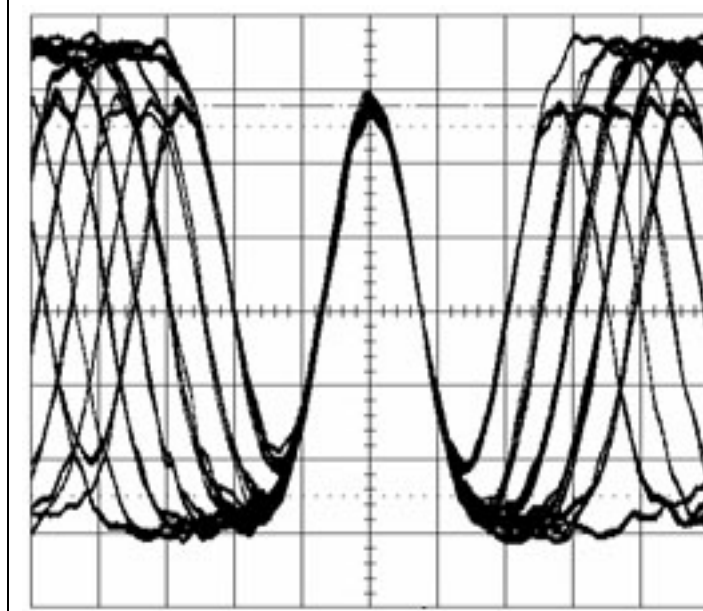

PWID PIT WIDTH

Description

Pit Width provides a measurement of the width of pits or spaces or both. The width of the pit or space is determined by the crossing of the selected voltage threshold. When **pwid** is selected as a parameter measurement it is generally useful to display the measurement calculation for a single 'nT' value. Otherwise the measurement will calculate the average width of 3T pits, 4T pits, and so on, which is meaningless. However, it is also often desirable to histogram the width of all pits and/or spaces. In this case the *range* of 'nT' values should be set to include all pit/space widths of interest.

Display Options

ORM parameter calculations can be displayed, histogrammed, and trended in a variety of ways. The table provides a concise description of the value or values displayed using each approach.

DISPLAY TYPE	VALUE DISPLAYED
Parameter Statistics Off	All values of the pit width for all pits/spaces within the selected 'nT' range for the last acquisition.
Parameter Statistics On	Average, minimum, maximum, and sigma of the pit width for all pits/spaces that are within the selected 'nT' range for all acquisitions since the last CLEAR SWEEPS operation.
nT Table	List of values of the average pit width for each group of pits/spaces of common 'nT' width for the last acquisition.
Histogram Function	Histogram graph of the value of the pit width for all pits/spaces within the selected 'nT' range for all acquisitions since the last CLEAR SWEEPS operation.
Trend Function	Trend graph of the value of the pit width for all pits/spaces within the selected 'nT' range for all acquisitions since the last CLEAR SWEEPS operation.

Example

The example shows that, measured at the selected voltage threshold, the CD data signal contains sequentially a 5T pit, 3T space, 3T pit, and 4T space. If the measurement is configured to select only 3T pits or spaces then the value displayed will be:

$$\text{pwid} = (694 \text{ ns} + 696 \text{ ns}) / 2 = 695 \text{ ns}$$

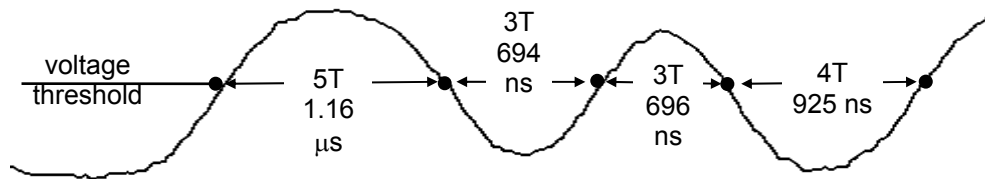

Example 2: Histogramming

Consider the problem of determining the error margin in an optical recording system. Because the data is encoded in the widths of the pits/spaces, it would be ideal for the widths to be exact integer multiples of the period of the clock used to sample the data signal. In practice this is not the case, but in order to ensure error-free data recovery, it is important for the widths to be grouped and separated.

Histogramming can be used to analyze the grouping of pit widths and to determine whether the separation is acceptable.

The scope is set up to acquire the optical data waveform by assigning Channel 1 to the data signal at a time/div of 0.2 ms, so that many pits/spaces can be gathered quickly. The signal is AC-coupled, so the threshold is set to 0 mV.

The **pwid** custom parameter is assigned to P1 and configured in the following manner:

- hysteresis = 0.5 divisions
- threshold = 0 mV
- polarity = Both
- range of n
- low $n = 3$
- high $n = 11$
- period = 231.5 ns.

F1 is defined as a zoom of channel 1 so that the waveform can be viewed expanded and the pits and spaces can be identified.

Using the **Math Setup** dialog, F2 is defined as the histogram of the **pwid** parameter on P1 and is set up as follows:

1. Use the maximum number of values (2,000,000,000)
2. Classify into 2000 bins
3. Linear vertical scale.

The trigger is set up to trigger on a pit edge and operated in normal trigger mode.

Note: Prior to acquisition, select each trace and press the RESET button to ensure that all the traces are reset.

In normal trigger mode, multiple waveforms are acquired and processed. The histogram will typically have data that is not well centered or is off screen. Touch the **FIND CENTER AND WIDTH** button to see the pit width distributions as they accumulate. After enough measurements have been taken, stop the triggering. After the histogram has been centered, the screen will look as follows:

The optical data waveform is on the top and the histogram is on the bottom. Notice the clustering of width distributions.

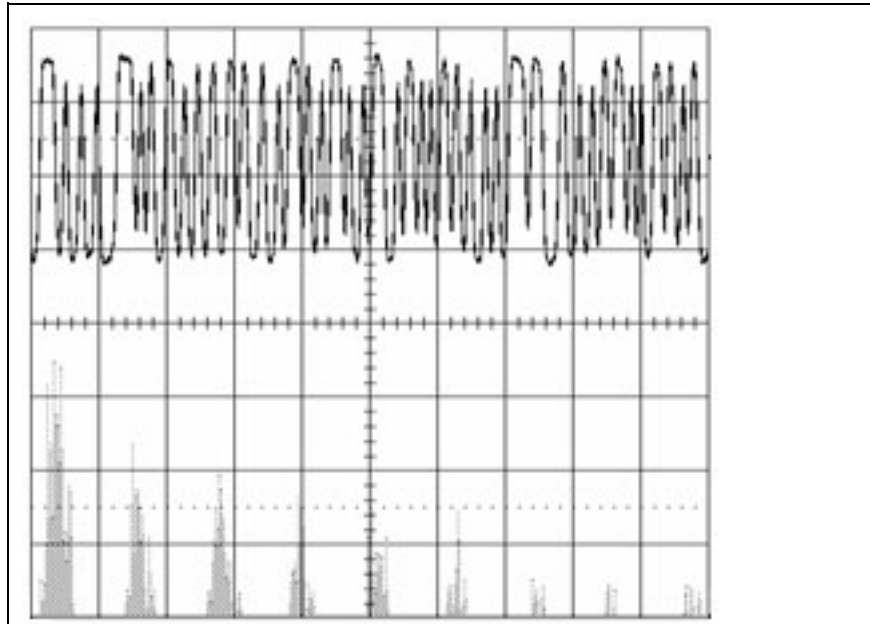

By enabling cursor tracking, the difference cursors are swept across the histogram. As expected, the space between the 3T and 4T distributions is the shortest, because of inter-symbol interference and the many 3T widths. The spacing is 138 ns.

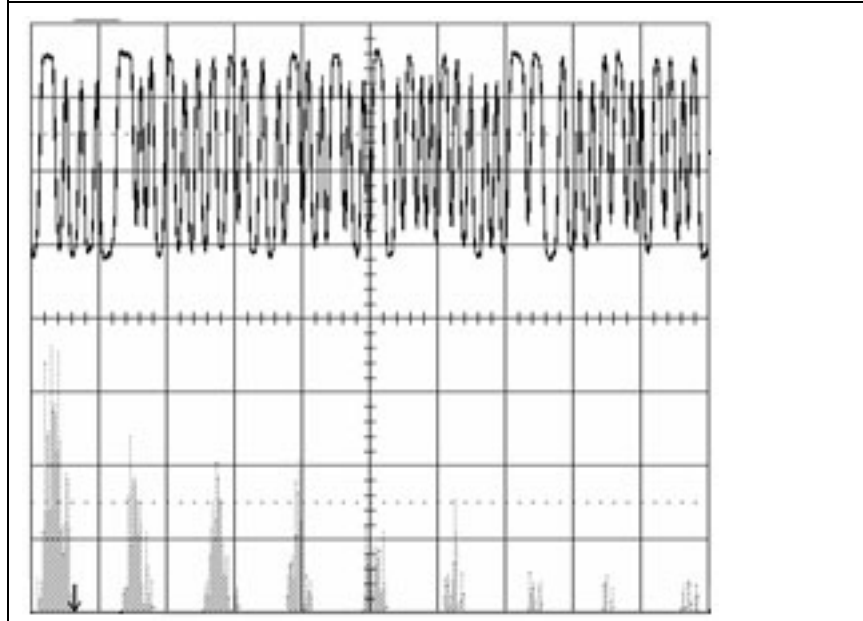

To measure the spread of widths for the distributions, set the measure mode to **My Measure** and configure the parameters:

1. P2: average of F2
2. P3: high of F2
3. P4: low of F2
4. P5: range of F2

Because parameter measurements are performed only on those portions of the waveform between the parameter cursors, activate tracking so that they can be swept across the histogram. Set the difference between the cursors so that they encompass one clock period. In this case, the histogram is shown at 0.2 μs per division. Set the difference between the parameter cursors to:

$$\frac{2315 \cdot 10^{-9}}{.2 \cdot 10^{-6}} = 1.16 \text{ divisions}$$

This screen shows the histogram statistics taken on the 5T distribution. The distribution has the largest spread of values: 102.5 ns. The mean is 1.1659 μ s, which is 3.6% higher than the ideal of 1.1575 μ s.

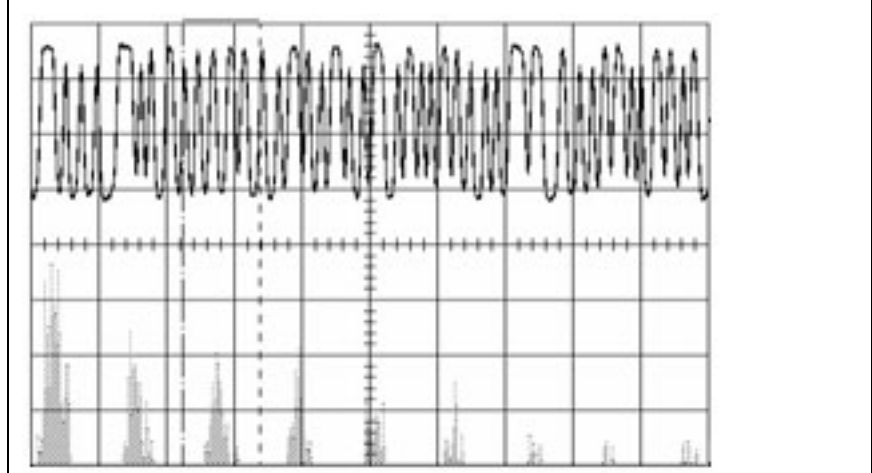

T@PIT TIME AT PIT

Description

The Time-at-Pit parameter provides the time of each leading edge of every pit or space within the nT range specified from the trigger point (time = 0). The value displayed is the time of the *first* pit only.

The usefulness of this parameter is not in the displayed value, but in its trending. The intent is that two parameters (t@pit and another ORM parameter) can be set up with identical configurations: precisely the same number of pits or spaces is found in the waveform, and precisely the same number of parameter measurements is made. When both of these parameters are trended, the two trends will have the same number of events, and there will be a one-to-one correspondence between each event in each trend. If both trends are displayed, and time cursors are swept over each, values will be displayed for the ORM parameter value and the time within the acquisition where the parameter measurement was made. These times are useful when searching for abnormal events within a waveform.

Not only can the trend of **t@pit** provide the actual event time, it can be used as the x-axis in an XY plot to examine modulation characteristics of particular parameter measurements.

Example

This example typifies the usage of the **t@pit** parameter. Step-by-step instructions are given.

A large optical recording waveform is to be acquired, and the ordinary pit/space widths that can cause errors in the system need to be found. The waveform contains pits/spaces that have widths that are ideal integer multiples of the clock period 231.5 ns in a range from 3 to 11 times this clock period.

The scope is set up to acquire this waveform by assigning Channel 1 to the data signal at a time/div of 0.2 ms. This signal will contain approximately 1800 pits/spaces. The ideal threshold (determined by the **pmidl** parameter) is 1.9 mV.

The **pwid** custom parameter is assigned to P1 and the **t@pit** parameter to P2. Both parameters are configured in the following manner:

- hysteresis = 0.5 divisions
- threshold = 1.9 mV
- polarity = Both
- range of n
- low $n = 0$
- high $n = 25$
- period = 231.5 ns.

Using the **Math Setup...** dialog, define F1 as the trend of the **pwid** parameter, and F2 as the trend of the **t@pit** parameter. For later use, define F3 as a zoom of Channel 1.

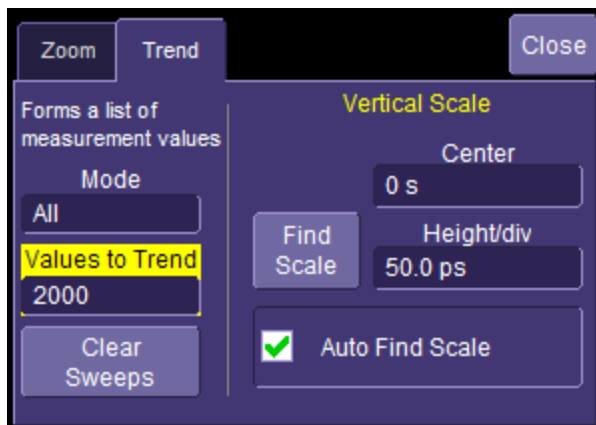

We are expecting 1800 pits/spaces, so make sure that the trends are set to use up to 2000 values for each math setup.

The trigger is set up to trigger on a pit edge and is operated in single-shot mode. For convenience, the waveforms are ordered on the screen in a particular manner:

1. F2: Trend of **t@pit**
2. F1: Trend of **pwid**
3. F3: Zoom of optical recording waveform

The reason for this order will become apparent.

Press the single-shot trigger button to acquire the waveform. The waveform should be centered on the screen. Typically the trends will have data that is not well centered or is off screen. Centering is done by touching the **FIND SCALE** button in each trend setup dialog.

The next screen shows what each trace looks like after the waveform has been acquired and the trends centered.

The waveforms are displayed in Quad grid mode. The trend of $t@pit$ is basically linear, as expected because the time at each pit from the trigger is ascending. The trend of the pit widths looks basically as expected. Notice that there are exactly as many events inside both trends, a necessary condition.

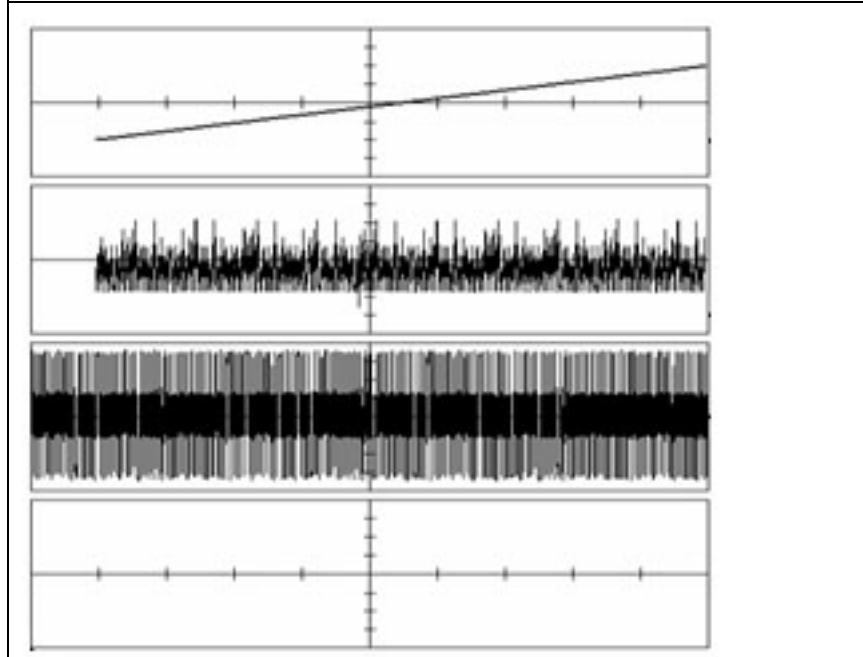

From the menu bar, select **Display Setup...** and set the grid mode to **XY**. Bands of pit widths corresponding to widths that are ideal integer multiples of the clock period will be evident. Select F2 (the trend of $t@pit$) and zoom to expand the time scale. Then select F1 (the trend of **pwid**) and use the vertical **Zoom** knob to adjust the band spacing. The vertical **Position** knob can be used to position the display vertically.

The next screens show the XY plot.

The XY plot has been adjusted so that all the pit widths are displayed vs. time. Notice that all form bands. This is because all but two are ideal integer multiples of the clock period. The two pit widths dissimilar to the others are sitting just below the 3T pit width band, and between the 4T and the 5T band. These strange pit widths occurred around the middle of the waveform.

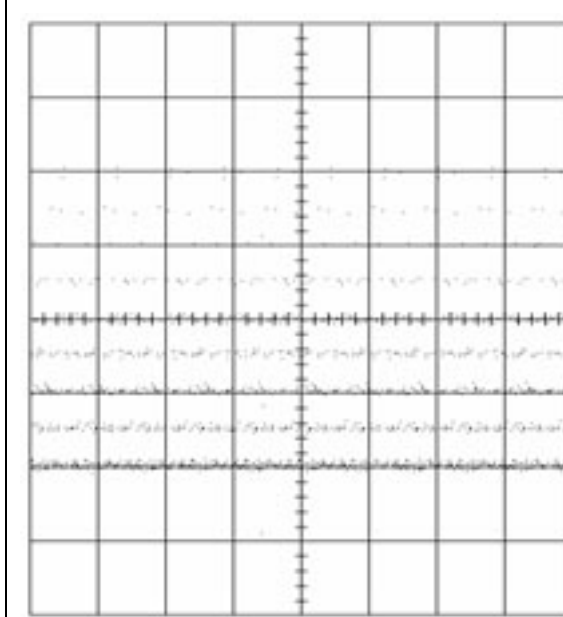

Using time cursors, it can be seen that the beginning of this problematic pit width occurred at pit # 973, 859.61 μs from the trigger. This smaller-than-normal pit is 245.40 ns.

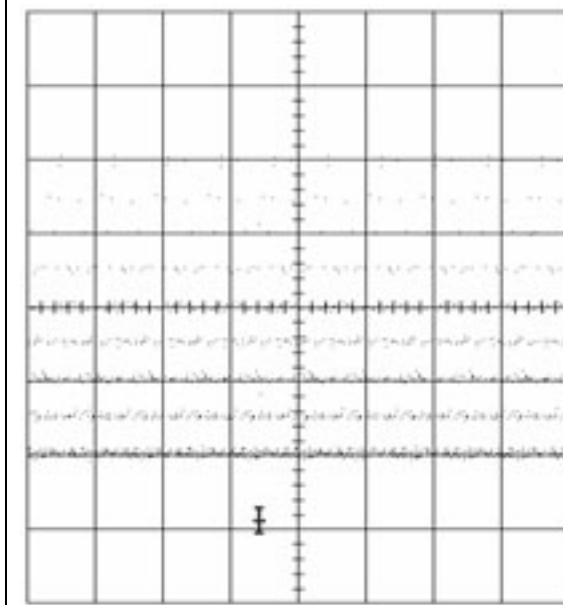

Now that a problem has been identified, we would like to view the portion of the waveform in which the problem occurred. Change the display mode **Single** grid. Turn off the two trend traces, leaving only F3, which is the expanded trace of Channel 1. Move the absolute time cursor to the position in the trace at 859 μs ; and, using the **WAVEPILOT** position controls, position the

waveform so that the cursor on the trace is at the center of the screen. Expand the waveform using the horizontal zoom control.

Here is the waveform zoomed in a bit with the measurement cursor placed at 859.600 μ s. As can be seen, there is some kind of aberration at the center of the trace.

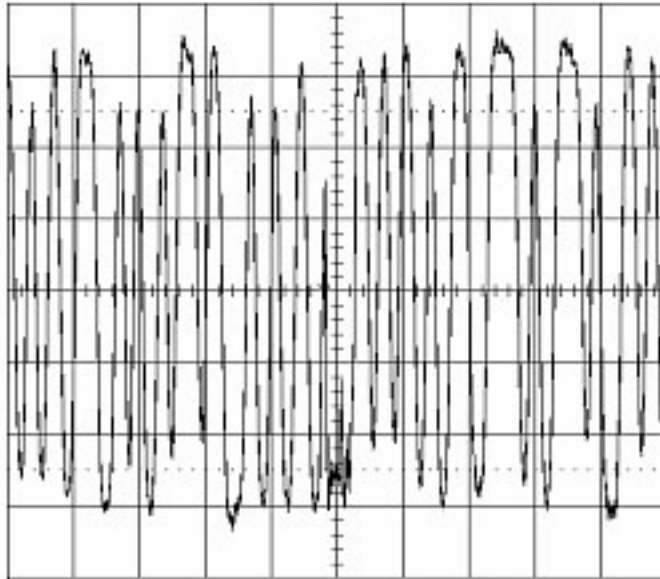

Further zooming clearly identifies the problem: a burst error that prevented the positive polarity width that starts at 859.61 μs from reaching its peak value. This defect caused the reflectivity to drop and to erratically fluctuate throughout the duration of the burst error. The defect affected the width of the next pit as well, which created the pit width centered between the 4T and 5T band of the XY plot.

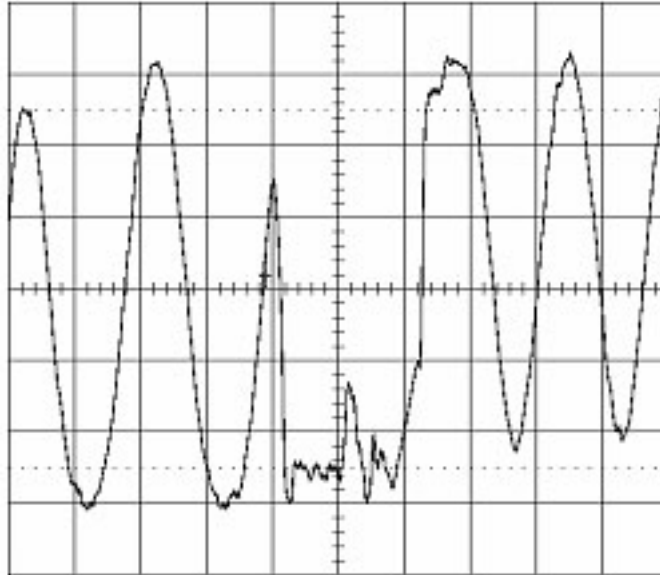

TIMJ TIMING JITTER

Description

Timing Jitter provides a measurement of the standard deviation of the difference of the width of pits and/or spaces from the mean width. The width of the pit/space is determined by the crossing of the selected voltage threshold. The measurement calculation is compliant with the definition of Timing Jitter as defined by ISO/IEC JTC1.23.14517 Section 22.4.

Display Options

ORM parameter calculations can be displayed, histogrammed, and trended in a variety of ways. The table provides a concise description of the value or values displayed using each approach.

DISPLAY TYPE	VALUE DISPLAYED
Parameter Statistics Off	Single value of the overall timing jitter for pits/spaces of interest for last acquisition.
Parameter Statistics On	Average, minimum, maximum, and sigma of the overall timing jitter value calculated per acquisition for all acquisitions since the last CLEAR SWEEPS operation.
nT Table	List of values of the timing jitter for each individual 'nT' in the selected range of 'nT' for the last acquisition.
Histogram Function	Histogram of the overall timing jitter values calculated for each acquisition for all acquisitions since the last CLEAR SWEEPS operation.
Trend Function	Trend of the overall timing jitter values calculated for each acquisition for all acquisitions since the last CLEAR SWEEPS operation.

Example

A waveform is acquired with 3T, 4T, and 5T pit widths as follows:

3T	4T	5T
695 ns	925 ns	1.16 μ s
690 ns		1.18 μ s
696 ns		

T is 231.5 ns, and the timing jitter parameter has been configured for a range of 3T through 5T.

The 3T mean is 693.66 ns. The 4T mean is 925 ns. The 5T mean is 1.17 μ s.

The 3T timing jitter is calculated by taking the standard deviation of the difference between each width and the 3T mean. This is 3.214 ns, normalized by:

$$Timj_{3T} = 3.214 \cdot \frac{100\%}{231.5} = 1.389\%$$

The 4T timing jitter cannot be calculated because there is only one value (at least two values are required).

The 5T timing jitter is +6.109%.

The overall timing jitter is calculated using a weighting formula, which results in the standard deviation of the mean centered distributions. In this example, it is calculated as:

$$Timj_{overall} = \sqrt{\frac{1.389^2 \cdot (3-1) + 6.109^2 \cdot (2-1)}{(3+2-1)}} = 3.208\%$$

More About Timing Jitter

In order to understand the operation of the timing jitter parameter with different modes of operation, consider the histogram of 3T to 5T pit widths in the next figure.

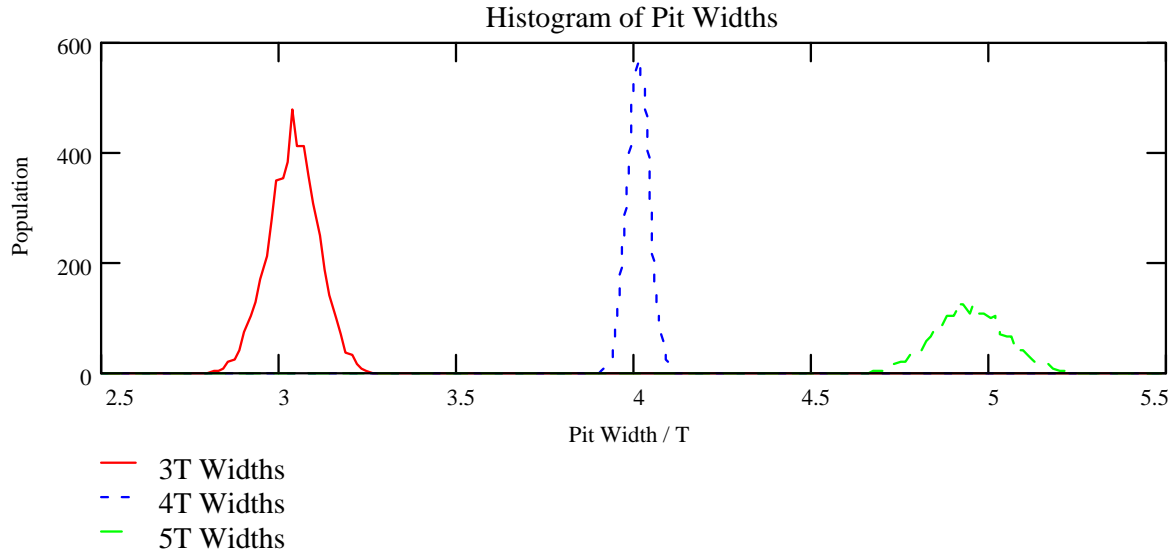

The Timing Jitter parameter considers each of these distributions separately. For each distribution the standard deviation is calculated. This is the timing jitter displayed for each nT distribution. Overall timing jitter is calculated by subtracting the mean width of each distribution from the widths in those distributions and considering the resulting superposition.

The sigma of the 3T, 4T, and 5T distributions are what is obtained when the Timing Jitter custom parameter is configured for single n values (the sigmas are the same as the sigma of the edge shift calculation). The sigma of the resulting superposition is what is obtained when the Timing Jitter custom parameter is configured for ranges of n values (in this case 3T to 5T).

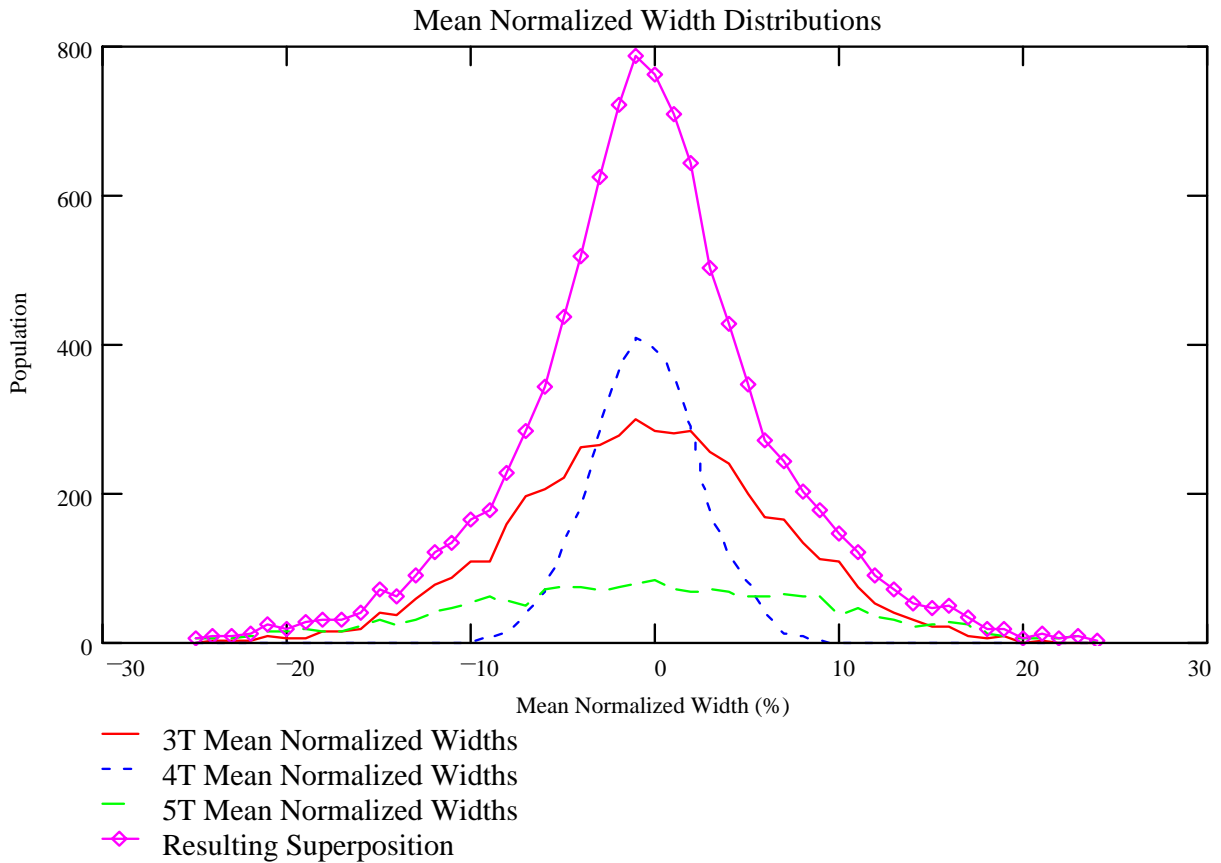

The value displayed on the custom parameter line (with statistics off) is the sigma of any of the resulting distributions *for the last acquisition only*. This timing jitter value is calculated internally without having to actually histogram the values. The values displayed in nT Table mode are the sigma of the width distributions resulting from each nT distribution *for the last acquisition*.

Note: Timing Jitter is always less than or equal to the standard deviation of superimposed Edge Shift distributions.

SIGNALS, COUPLING, AND THRESHOLD SETTINGS

Which optical recording signal, or combination of signals should be used in a calculation? How should the signal be coupled, or the threshold set? The answers to these questions are sometimes uncertain. This appendix offers tips on how to answer them.

Choice of Signals

Generally, the choice of signals depends on the aim of the measurement. For example, if the quality of the signal direct from the media is being examined, generally the signal at the output of the photodetector should be used. Alternatively, a conditioned signal could serve the purpose.

A “sliced” or logic conditioned signal should normally be chosen when precise timing measurements are desired and propagation delay through the logic device (comparator) is not an issue. Timing measurement accuracy is improved when a fast signal is used, as opposed to the slower signals at the photodetector, for the following reasons:

- A fast edge usually results in more accurate timing measurements because of interpolation algorithms, as long as points are sampled along the edge.
- A fast edge provides a threshold crossing time and, therefore, measurement accuracy more immune to noise.
- The use of the signal at the output of a logic device or comparator decreases the sensitivity of the measured threshold-crossing time to the exact value of the threshold level selected.
- The use of the signal at the output of a logic device or comparator typically solves other threshold problems as well, in systems that dynamically adjust the threshold based on the optical recording data signal. Sliced or logic signals facilitate the use of a fixed threshold.

Coupling

DC coupling is required only for measurements of absolute DC values. Measurements requiring it include **ptop**, **pbase**, **pmin**, **pmax**, and **pmoda**. Otherwise, AC coupling is best used on signals that are not outputs of logic devices or comparators: those that might have varying thresholds.

Threshold Selection

If DC coupling must be used, there are some further considerations for threshold selection. While all of the optical recognition measurements specify thresholds used to extract the pits/spaces (by recording threshold crossings), there is a variance in the sensitivity of parameters to the exact threshold value selected. The sensitive parameters are those that are time related or whose values depend on the exact time of the threshold crossing. Those insensitive to the exact threshold value are parameters that use the threshold crossing time only to categorize the parameter result according to width (that is, they use the crossing time only to find the width for determining the nT index to which the pit/space belongs).

In the case of threshold-insensitive parameters, it usually suffices to use a fixed threshold somewhere in the middle of the optical recognition waveform. Even if the signal's middle shifts, the fixed threshold is usually adequate.

Additionally, if the signal is AC coupled, it will tend not to shift much, and the fixed threshold will be perfectly adequate.

The problem arises when what is required is a DC-coupled signal with a threshold that changes dynamically throughout the waveform. There remains a possible solution, but the scope setup is slightly more complicated.

Consider the fact that AC coupling can be regarded as rejection of the DC component of a signal, or subtracting it from the signal. In many systems, the threshold is determined in precisely this manner by applying a low-pass filter to the signal, and then applying this value, with the signal itself, to the input of a comparator. If a threshold value determined in this manner is available in the circuit, the threshold signal, along with the optical recognition data signal itself, should be acquired. Waveform math can then be used to subtract the threshold signal. This is done by defining a trace as the Arithmetic Difference of the raw data signal and the threshold signal. The new trace is then used as the optical recognition data signal in the parameter calculations.

Regardless of how the signal is coupled, there are other considerations involved in determining the appropriate threshold. If waveform math is used, the threshold is always 0 V. Otherwise, the optimum threshold is best determined using the **pmidl** parameter.

Some optical recognition standards define the middle level of the 3T signal as the “decision level.” **Pmidl** configured for the single 3T pits/spaces is an ideal candidate for the best threshold value. Another candidate is the **pmidl** value calculated using the entire range of n indices possible. In this way, **pmidl** calculates the best overall threshold level as a weighted average of middle levels calculated for each n index.

In AORM, the ODATA function can be used to remove these effects. Its “leveled” output subtracts the “threshold” (low frequency content of the signal) from the input data.

USING PARAMETERS WITH TRENDS AND XY PLOTS

X-axis	Y-axis	
t@pit	Dp2c edgsh pbase pmax pmin ptop pwid	<p>We saw in the t@pit parameter description how the ORM parameters have certain unique characteristics that make particular measurements useful when trended together with XY plots. And how the t@pit parameter is essential to those measurements. Plots that can be generated on single acquisitions include those listed in the table at left.</p> <p>The reason that these plots are considered useful on single acquisitions is because the parameters are guaranteed to be configurable in a manner that meets the following criteria:</p> <ul style="list-style-type: none"> • Each parameter is capable of providing multiple values per acquisition. • Each parameter pair is configurable in a manner that guarantees the same number of events per waveform. • Each parameter pair must be configurable in a manner that guarantees a one-to-one correspondence between parameter calculation values.
pwid	pbase pmax pmin ptop	
ptop	pmax	
pbase	pmin	

Example and Step-by-Step Instructions

Here is an example typifying the use of XY plots without the **t@pit** parameter. A complete example using **t@pit** has been provided in the section dedicated to this parameter description.

Consider a situation in which it is desirable to find the relationship of the pit top value to the pit width in an optical recognition data waveform:

The scope is set up to acquire this waveform by assigning Channel 1 to the data signal at a time/div of 0.2 ms. This signal will contain approximately 1800 pits/spaces. The ideal threshold has been determined by the **pmidl** parameter as 1.9 mV.

The **ptop** custom parameter is assigned to P1, and the **pwid** parameter is assigned to P2. Use configuration **tracking** to configure both parameters in the following manner:

hysteresis = 0.5 divisions
 threshold = 1.9 mV
 polarity = Pos
 range of n
 low $n = 3$
 high $n = 11$
 period = 231.5 ns

In math setup, F1 is defined as the trend of the **ptop** parameter and F2 as the trend of the **pwid** parameter. Because we are expecting 1800 pits/spaces, make sure that for each math setup the trends are set to use up to 20,000 values, the maximum amount.

Note: If configuration tracking is used on the ptop parameter, the pwid parameter must be visited in order to set the polarity to positive because ptop inherently implies positive polarity pits.

The trigger is set to trigger on a pit edge and is operated initially in single-shot mode. For convenience, the waveforms are ordered on the screen in a particular manner so that they will automatically work correctly with XY display mode:

1. F2: Trend of **t@pit**
2. F1: Trend of **pwid**
3. Channel 1: optical recognition data signal

Note: Prior to acquisition, select each trace and press the **RESET** button to ensure that all the traces are reset.

The single-shot trigger button is pressed and the waveform acquired. The waveform should be centered on the screen. The trends will typically have data not well centered or off-screen. These traces can be positioned on the grid by touching the **FIND SCALE** button in each trend setup dialog. The screen shown here is what each trace looks like after the waveform has been acquired and the trends centered.

The waveforms are displayed in Quad grid mode. Notice that there are exactly as many events inside both trends, a necessary condition. Although the trends are very short (containing only 902 out of the total 20,000 pits allowed) repeated triggering will eventually fill in both trends sufficiently.

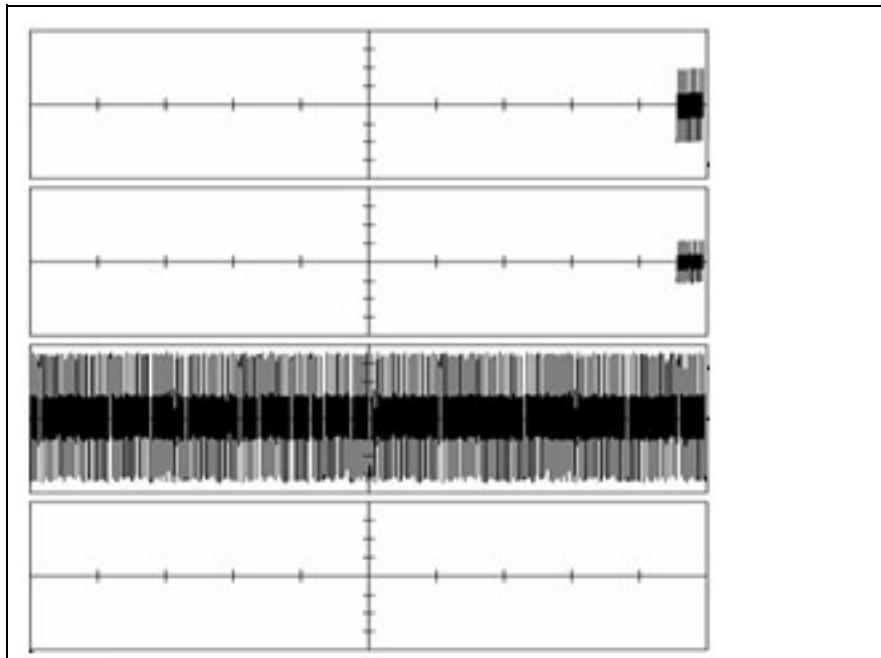

Set the display mode to XY. Clusters of pit top values will be apparent: clustered because the tops tend to be approximately the same amplitude and the pit widths approximate multiples of the clock period. Select F2 (the trend of **pwid**) and use the vertical **ZOOM** control to expand the X-axis scale. Select F1 (the trend of **ptop**) and use the **ZOOM** knob to adjust the vertical scale. The vertical **POSITION** knob can be used to position the display vertically.

This is what the XY plot looks like:

The XY plot has been adjusted so that all of the pit tops are displayed vs. Pit width. Notice that all of the pit widths form clusters.

*Press **NORMAL** trigger, and the clusters will become even more dense. You can have up to 20,000 points in the XY plot.*

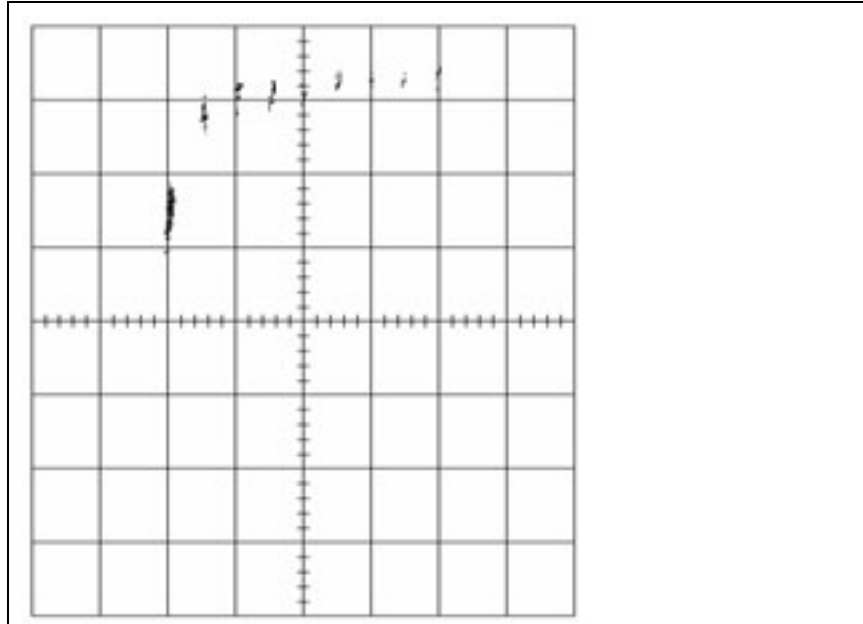

Using the XY cursors, a variety of measurements can be performed simultaneously. For example, here it can be seen that the 5T pit width varies by approximately 82 ns and the top varies by approximately 2.58 mV. Of course these could be seen through automatic parameter calculations without using XY plots, but the XY plot can sometimes provide information that would not otherwise be observable.

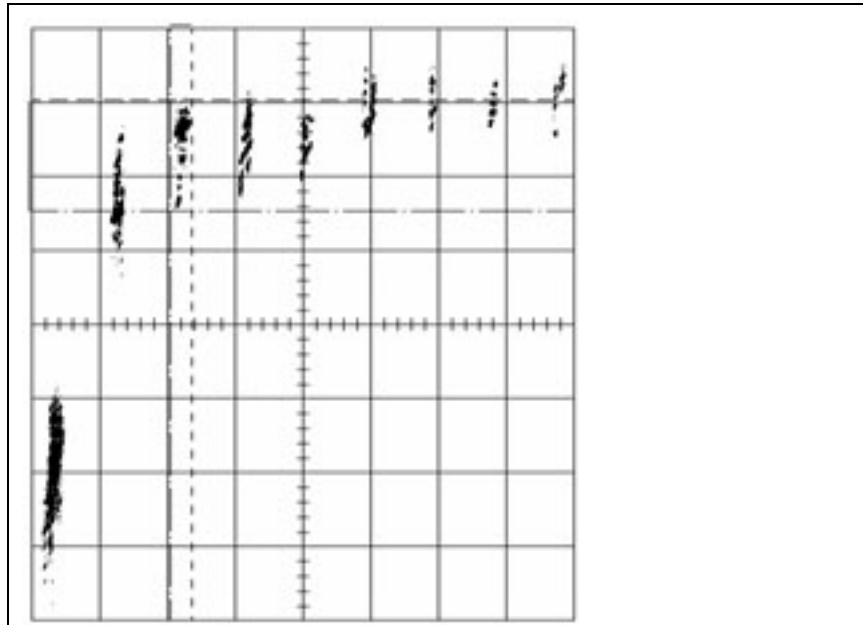

IMPROVING HORIZONTAL MEASUREMENT ACCURACY

Horizontal measurement accuracy pertains to timing-related measurements. In the AORM package, these are Dp2c, Dp2cs, edgsh, lper, pwid, t@pit, and timj. In many cases, measurement accuracy can be improved by considering certain items pertaining to how a DSO operates and how parameters are measured.

DSOs sample the signal, building a waveform that consists of points at intervals determined by the sample rate. One obvious consideration for maximizing horizontal measurement accuracy is to ensure that the highest sample rate possible is used. On low time/divs, waveforms become long. Thus it is important to set the **Max Sample Points** value in the SMART Memory dialog to the largest possible value. This ensures the highest sample rate based on the time/div setting.

Times are calculated for ORM parameters by interpolating between points that straddle the threshold specified. Measurement accuracy is improved when the edge is:

- fast enough to enable points straddling the threshold that are far from the threshold, and
- slow enough, and the sample rate high enough, to enable points to be sampled on the edge.

In most cases, these considerations are taken into account by sampling at the highest rate possible and by ensuring that the volts/div setting is as low as practically possible.

Note on RIS (Random Interleaved Sampling)

RIS is a mechanism used by the oscilloscope to increase the effective sample rate by interleaving samples taken over multiple waveform acquisitions. The scope enters RIS mode automatically when the time/div setting is set extremely low.

Because multiple acquisitions are interleaved in RIS, a highly stable trigger signal must be maintained, and precisely the same waveform acquired on each acquisition.

For most ORMs, RIS is neither appropriate nor recommended. If not used properly, it will result in erroneous measurements.

(For more on RIS, see your scope's Operator's Manual.)

BASE AND TOP CALCULATION DETAILS

The base and top are designed to emulate results in the past obtained from persistence plots. In general, the top was calculated by examining the most intense region near the top of a waveform in an eye-pattern persistence map. The AORM package improves on this in that the tops of *all* pits are calculated independently: rogue amplitude variations in the waveform can be identified.

The waveform in the next figure contains two pits. We need only consider the first of these.

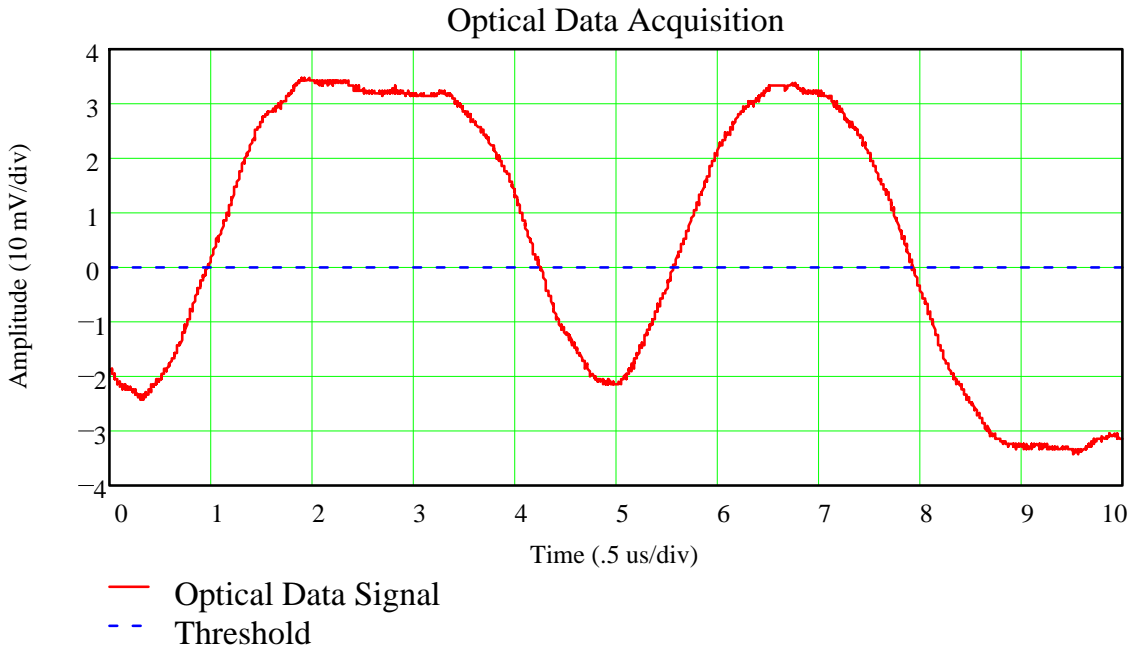

The AORM package histograms the values inside each pit to determine the most likely amplitude: the most densely populated region.

The next figure shows the histogram of the pits' amplitudes. It is easily seen that the most likely amplitude is approximately 32 mV (exactly 31.9 mV). The top is calculated by averaging all of the waveform data points at or above this, to give a result of 32.89 mV.

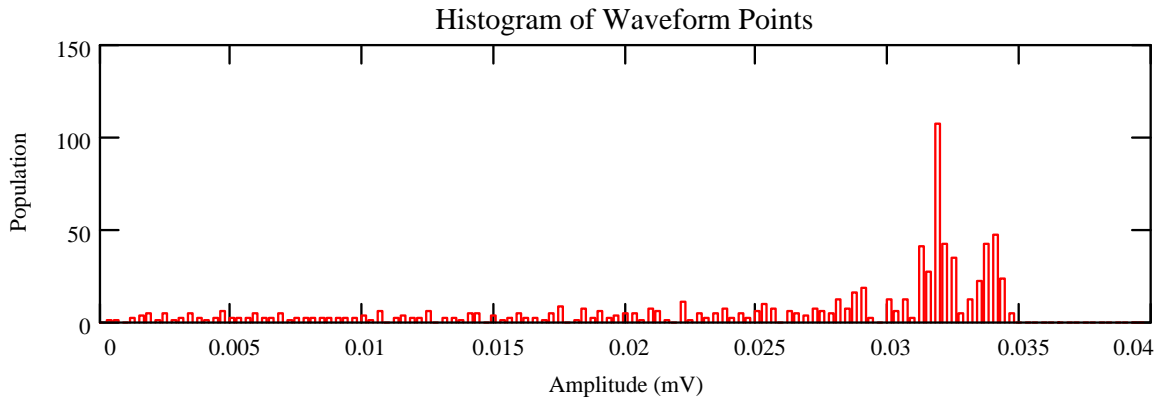

In the next figure, the top bisects the two flattest regions at the top of the waveform and, in effect, calculates the value that would be estimated from examination of an eye-pattern persistence map.

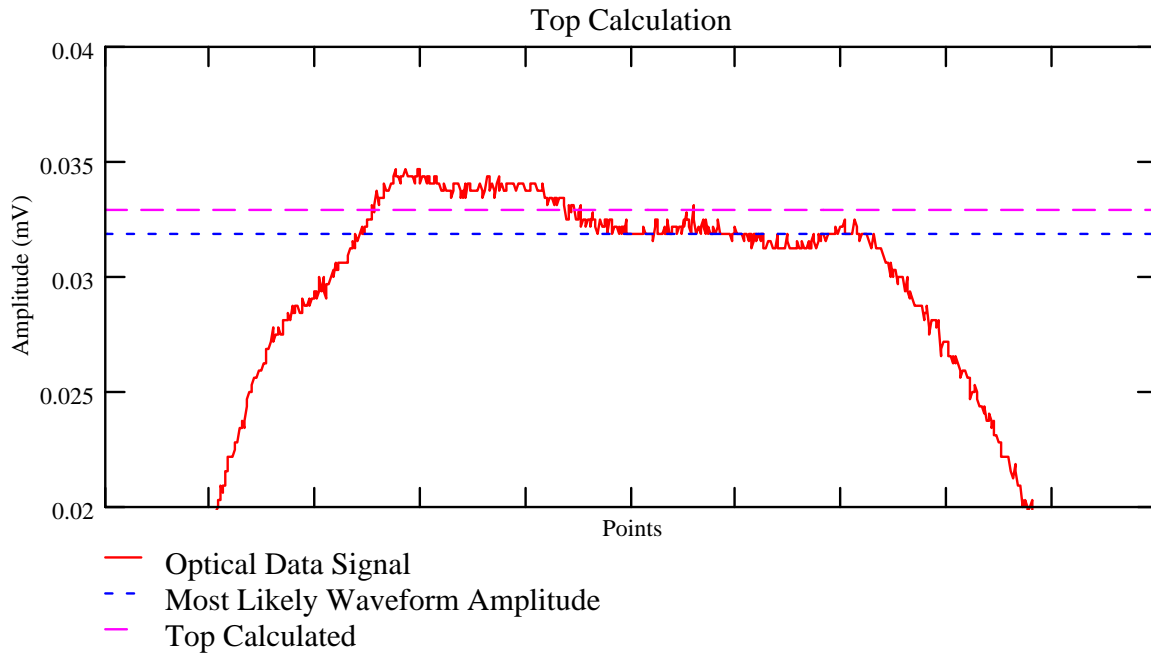

THEORY OF OPERATION

An understanding of statistical variations in parameter values is needed for many waveform parameter measurements. Knowledge of the average, minimum, maximum, and standard deviation of the parameter may often be enough, but in many other instances a more detailed understanding of the distribution of a parameter's values is desired.

Histograms provide the ability to see how a parameter's values are distributed over many measurements. They divide a range of parameter values into sub-ranges called bins. A count of the number of parameter values calculated (events) that fall within its sub-range is maintained for each bin.

While the range can be infinite, for practical purposes it need only be defined large enough to include any realistically possible parameter value. For example, in measuring TTL high-voltage values a range of ± 50 V is unnecessarily large, whereas one of $4 \text{ V} \pm 2.5 \text{ V}$ is more reasonable. It is this 5 V range that is subdivided into bins. And if the number of bins used were 50, each would have a sub-range of 5 V per 50 bins or 0.1 V/bin. Events falling into the first bin would then be between 1.5 V and 1.6 V. The next bin would capture all events between 1.6 V and 1.7 V. And so on.

After several thousand events, the graph of the count for each bin (its histogram) provides a good understanding of the distribution of values. Histograms generally use the X-axis to show a bin's sub-range value, and the Y-axis for the count of parameter values within each bin. The leftmost bin with a non-zero count shows the lowest parameter value measurements. The vertically highest bin shows the greatest number of events falling within its sub-range.

The number of events in a bin, peak, or histogram is referred to as its population. The next figure shows a histogram's highest population bin as the one with a sub-range of 4.3 to 4.4 V, which is to be expected of a TTL signal. The lowest value bin with events is that with a sub-range of 3.0 to 3.1 V. Because TTL high voltages need to be greater than 2.5 V, the lowest bin is within the allowable tolerance. However, because of its proximity to this tolerance and the degree of the bin's separation from all other values, additional investigation may be desirable.

Teledyne LeCroy DSO Process

Teledyne LeCroy digital oscilloscopes generate histograms of the parameter values of input waveforms. But first, the following must be defined:

- The parameter to be histogrammed
- The trace on which the histogram will be displayed
- The maximum number of parameter measurement values to be used in creating the histogram
- The measurement range of the histogram
- The number of bins to be used

Once these are defined, the oscilloscope is ready to make the histogram.

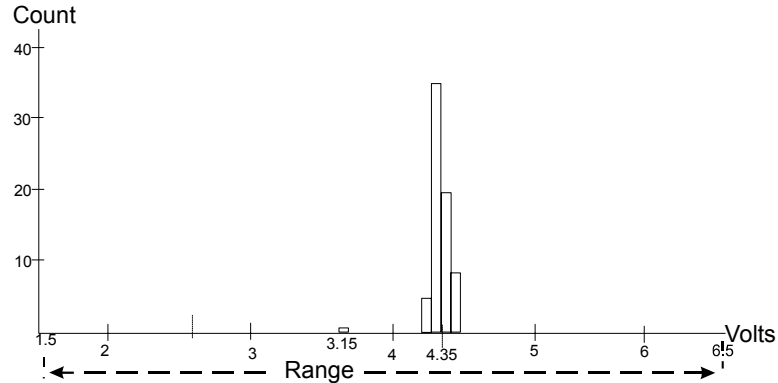

The sequence for acquiring histogram data is:

1. trigger
2. waveform acquisition
3. parameter calculations
4. histogram update
5. trigger re-arm.

If the timebase is set in non-segmented mode, a single acquisition occurs prior to parameter calculations. However, in Sequence mode an acquisition for each segment occurs prior to parameter calculations. If the source of histogram data is a memory, storing new data to memory effectively acts as a trigger and acquisition. Because updating the screen can take significant processing time, it occurs only once a second, minimizing trigger dead-time (under remote control the display can be turned off to maximize measurement speed).

Parameter Buffer

The parameter buffer allows you to include up to one million values in the trend calculation.

Parameter Events Capture

The number of events captured per waveform acquisition or display sweep depends on the parameter type. Acquisitions are initiated by the occurrence of a trigger event. Sweeps are equivalent to the waveform captured and displayed on an input channel (1, 2, 3, or 4). For non-segmented waveforms an acquisition is identical to a sweep. Whereas for segmented waveforms an acquisition occurs for each segment and a sweep is equivalent to acquisitions for all segments. Only the section of a waveform between the parameter cursors is used in the calculation of parameter values and corresponding histogram events.

Histogram Parameters

Once a histogram is defined and generated, measurements can be performed on the histogram itself. Typical of these are the histogram's:

- Average value, standard deviation
- Most common value (parameter value of highest count bin)
- Leftmost bin position (representing the lowest measured waveform parameter value)
- Rightmost bin (representing the highest measured waveform parameter value).

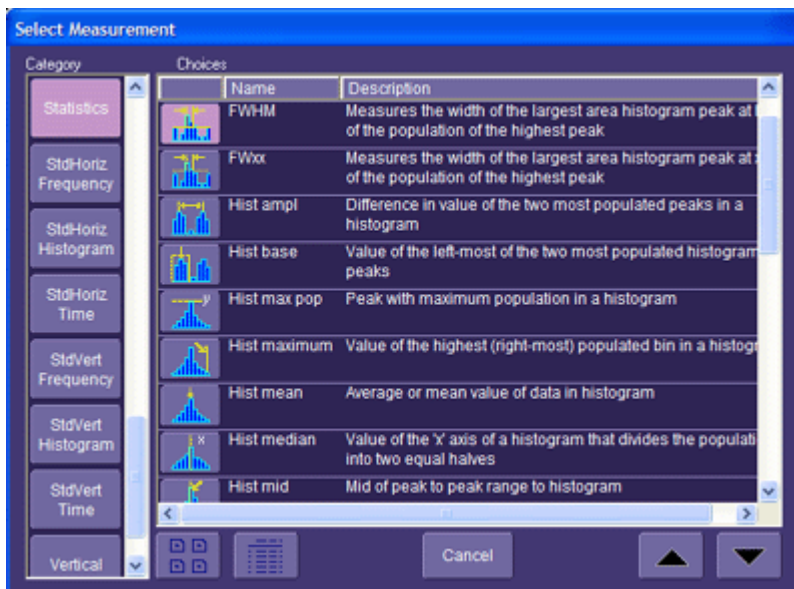

Histogram parameters are provided to enable these measurements. Accessible by selecting **Statistics** from the **Select Measurement** menu, they are calculated for the selected waveform section between the parameter cursors:

avg	average of data values in histogram
fwhm	full width (of largest peak) at half the maximum bin
fwxx	full width (of largest peak) at xx% the maximum bin
hampl	histogram amplitude between two largest peaks
hbase	histogram base or leftmost of two largest peaks
high	highest data value in histogram
hmedian	median data value of histogram
hrms	rms value of data in histogram
htop	histogram top or rightmost of two largest peaks
low	lowest data value in histogram

maxp	population of most populated bin in histogram
mode	data value of most populated bin in histogram
pctl	data value in histogram for which specified 'x'% of population is smaller
pks	number of peaks in histogram
range	difference between highest and lowest data values
sigma	standard deviation of the data values in histogram
totp	total population in histogram
xapk	x-axis position of specified largest peak.

Zoom Traces and Segmented Waveforms

Histograms of zoom traces display all events for the displayed portion of a waveform between the parameter cursors. When dealing with segmented waveforms, and when a single segment is selected, the histogram will be recalculated for all events in the displayed portion of this segment between the parameter cursors. But if **All Segments** is selected, the histogram for all segments will be displayed.

Histogram Peaks

Because the shape of histogram distributions is particularly interesting, additional parameter measurements are available for analyzing these distributions. They are generally centered around one of several peak value bins, known (with its associated bins) as **HistX@peak**.

Example

In the next figure, a histogram of the voltage value of a five-volt amplitude square wave is centered around two peak value bins: 0 V and 5 V. The adjacent bins signify variation due to noise. The graph of the centered bins shows both as peaks.

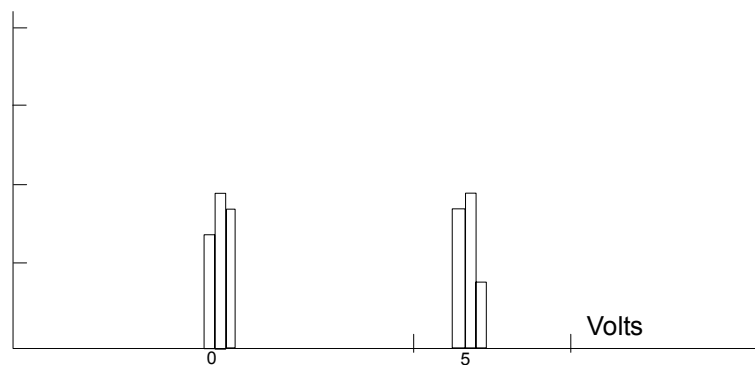

Determining such peaks is very useful because they indicate the dominant values in a signal.

However, signal noise and the use of a high number of bins relative to the number of parameter values acquired can give a jagged and spiky histogram, making meaningful peaks hard to distinguish. The scope analyzes histogram data to distinguish peaks from background noise and from histogram definition artifacts such as small gaps, which are due to very narrow bins.

Binning and Measurement Accuracy

Histogram bins represent a sub-range of waveform parameter values, or events. The events represented by a bin may have a value anywhere within its sub-range. However, parameter measurements of the histogram itself, such as average, assume that all events in a bin have a single value. The scope uses the center value of each bin's sub-range in all its calculations. The greater the number of bins used to subdivide a histogram's range, the less the potential deviation between actual event values and those values assumed in histogram parameter calculations.

Nevertheless, using more bins may require performance of a greater number of waveform parameter measurements in order to populate the bins sufficiently for the identification of a characteristic histogram distribution.

In addition, very fine-grained binning will result in the creation of gaps between populated bins that may make determination of peaks difficult.

The oscilloscope's parameter buffer is very effective for determining the optimal number of bins to be used. An optimal bin number is one where the change in parameter values is insignificant, and the histogram distribution does not have a jagged appearance. With this buffer, a histogram can be dynamically redisplayed as the number of bins is modified by the user. In addition, depending on the number of bins selected, the change in waveform parameter values can be seen.

DVD PROCESSING MODEL

In many applications, it is important to make measurements directly from the RF signal, independent of a specific DVD chip. The OData processing function provided in the Advanced ORM package can emulate the filter, slicer, and/or phase-locked loop (PLL) of a typical optical recording drive. A schematic of this function is shown in the following diagram. You can view the equalized, leveled data, threshold, sliced data, or the extracted clock.

You can control the cutoff frequency and boost of the equalizing filter, the closed loop bandwidth of the slicer, and the bandwidth of the PLL. Alternatively, you can input the equalized signal and still look at the slicer or PLL output of the function.

Additionally, some of the advanced optical drives have a header and data section. A Gate signal differentiates the header and data sections. The OR Data function lets you input a gate signal, and allows you to choose when to analyze the data (gate high or low), so that either the header or the data area can be analyzed.

DVD RAM

For noisy signals if less than three width peaks are found, the PLL start frequency is set so that T is the nearest value to the expected bit rate for which the first width peak is an integer multiple of T . Also, the PLL start phase is derived from the first two edges instead of the first one.

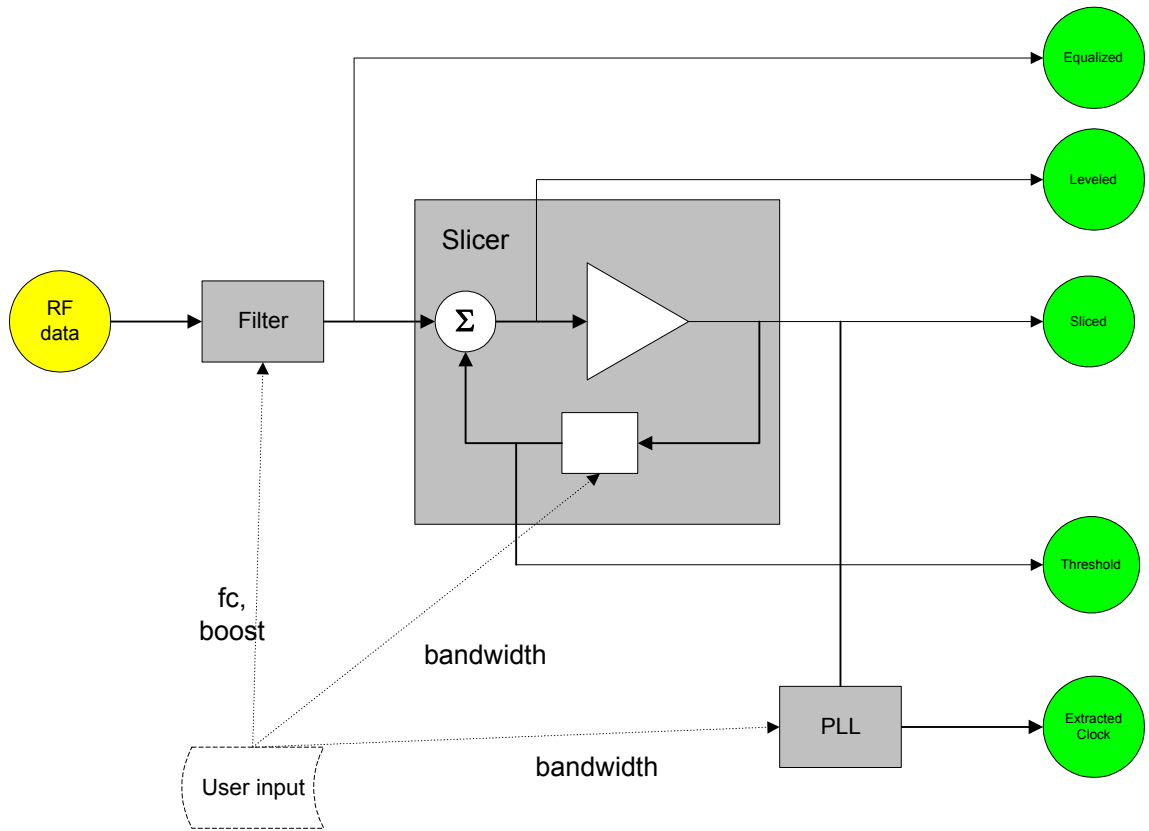

Where:

- Equalized – applies a low pass filter with boost to the input data. This should not be used if the input data is already equalized (filtered).
- Leveled – Applies the filter (if the input data is raw RF) and then subtracts the sliced threshold from it.
- Sliced – This is the output of the slicer. It is similar to Leveled except the amplitude of each pulse is normalized to “1” and “0.”
- Threshold – this waveform comprises the low frequency components of the original signal.
- Extracted CLK – the sliced data is passed through a PLL and the recovered clock signal is produced.

FILTERING

A low-pass filter that removes high-frequency noise and provides equalization is needed for the newer optical recording systems (e.g., DVD). In the DVD read-only and recordable specifications are given the frequency characteristics of the low pass filter (LPF) and equalizer (EQ) as a graph. The combination of these must meet within 1 dB below 7 MHz, and it is recommended to meet it up to 10 MHz. Also, group delay variation for frequencies ≤ 6.5 MHz must be $\geq \pm 3$ ns, and gain at 5.0 MHz minus gain at 0 Hz must be 3.2 ± 0.3 dB. For the LPF, it gives an example implementation to achieve these characteristics as a 6th order Bessel filter with a cutoff frequency f_c (-3dB) = 8.2 MHz, and an example for the EQ is a three-tap transversal filter.

The OData function implements the 6th order Bessel filter as a FIR filter to provide the low-pass filter capability. The number of coefficients of the FIR depends on the ratio between the cutoff frequency f_c and the sample rate f_s . For a 1x DVD with an f_c of 8.2 MHz, sampled at 500 MS/s, approximately 220 taps are required. Sampling at 1 GS/s is about twice that. Ideally, the sampling rate should be 10 to 20 times the clock rate. For a 1x DVD with a clock period of 37 ns, the sample rate should be 500 MS/s.

The three-tap equalization filter (EQ) is applied to the data after it has been low-pass filtered. The three samples input to the EQ are not adjacent; they are at 0 and $\pm 2T$, where T is a 1/channel bit rate.

Because the spacing in DSO samples depends on data rate and sample rate, T is likely to be a non-integer number of samples. In this case, interpolation is used to find the values at $-2T$ and $+2T$.

SLICER

The Slicer is a 1st order integrating slicer with a programmable closed loop bandwidth (e.g., 5 kHz for 1x DVD as specified in DVD-R Annex G and DVD Annex H). Besides producing the sliced data, the slicer can output the difference of the input signal and the slicer threshold level. The slicer threshold will be determined by an exponential average of data samples computed as:

$$\text{New thresh} = (n - 1)/n * \text{old thresh} + 1/n * \text{new data}$$

Where n is chosen to meet the bandwidth requirement at the current sample rate.

Parameter	Description	Possible Values
Cutoff frequency	Cutoff frequency for the Equalizer (low-pass filter)	10 kHz to 800 MHz
Boost	Boost for the Equalizer	0 to 20 dB
Slicer BW	Controls the bandwidth of the Slicer	1 to 200 kHz
PLL BW	Controls the bandwidth of the PLL (used for clock recovery only)	1 to 200 kHz

AORM Software Package

Gate	Optionally, you can specify a channel that will be used to gate the input signal. When specified, you must also specify the polarity of the gate (i.e., process when low or high).	None, C1, ... C4, M1, M4, other traces High or Low
------	--	---

APPENDIX A: NOTES ON ODATA MATH FUNCTION

The ORDATA math function can accept as input either unequalized or already equalized data, and produce:

- **Equalized:** If the input data is not already equalized, the instrument applies equalization using the **Filter Cutoff** and **Boost** settings from the "Equalizer and PLL" dialog. The result is low-pass filtered such that -3dB frequency, without boost, is the filter cutoff frequency, and has high frequency boost applied such that the specified boost is reached at about 61% of the filter cutoff frequency. The default values for cutoff frequency (8.2 MHz) and boost (3.2 dB) are the correct settings for 1x DVD and DVD-R.
- **Leveled:** The data is fed to a 1st order integrating low-pass filter whose bandwidth is set by **Slicer BW** in the "Equalizer and PLL" dialog. The default slicer bandwidth (5.0 kHz) is correct for 1x DVD and DVD-R. The output of this filter is subtracted from the waveform to move the correct slice level to zero. Leveled output may be used for pit width measurements, etc. The correct level for the parameter threshold is always zero volts when it is used on leveled data.
- **Extract Clk:** The sliced data is sent through a PLL emulation, and the output is the PLL's VCO output. This uses the **PLL BW** setting in the "Equalizer and PLL" dialog. The default PLL Bandwidth (9 kHz) is the correct setting for 1x DVD and DVD-R. The VCO's starting frequency and phase are preset to attempt to start the PLL in a "locked" condition on each sweep.

This appendix contains more information about each of these operations, including known limits on their operations. Extracting the clock from the data has the most dependencies; if you plan to use that function, please see the appropriate following section.

Equalized

Equalization can be applied if three conditions are met:

- We can make the low-pass filter.
- We can apply boost.
- The waveform is large enough to still have valid points after the filtering.

A warning message is displayed if any of these conditions is not met. If one of the following warning messages appears, the waveform is NOT equalized:

- "LP fc low & sample rate too high, can't LP filter": The number of coefficients needed for the finite impulse response (FIR) low-pass filter exceeded the maximum number supported. The maximum is adequate for 1x DVD at 16 GS/s, which means the maximum ratio of sample rate to cutoff frequency is $16e9/8.2e6 = 1951.22$. This is far above the maximum it is reasonable to use. See the note on computation time under "Operational Notes."

- "Acquisition too small to apply EQ filters": The valid region of the waveform is reduced by "EQ spacing" (see following explanation) on each side. This error message means that the result would then have no valid points.
- "LP fc low & sample rate too high, can't EQ filter": This message is shown if current EQ spacing is greater than 8191 samples, an implementation restriction. The EQ spacing is set to correspond to 2T, assuming that the cutoff frequency is correctly set; it is calculated from the cutoff frequency as follows:

$$\text{EQ spacing in samples} = 2.0 / (f_c * 26.16 / 8.2) * \text{sample interval}$$

Operational Notes

1. Even if the input data is already equalized, it is often helpful to tell the ODATA function that it is not, but set the boost to zero. This greatly reduces noise. White noise has power per Hz of bandwidth, and reducing the scope's bandwidth to around 8.2 MHz gets rid of 99% of white noise.
2. Applying high-frequency boost makes short pulses larger and has less effect on longer pulses. The correct boost should not greatly increase the signal's overall amplitude.
3. The output of the equalization is not delayed, as it would be by an analog filter. We compensate for the known delay through the digital filter and replace each input point with the corresponding equalized point.
4. The FIR LP filter plus 3.2 dB boost from the three-tap EQ filter produces the transfer function shown in the next figure when the FIR f_c is set to 8.2 MHz. The highest peak is 20 log (dB) magnitude. The bowed trace below it is the real component of the TF. The flat line at zero is the imaginary component of the TF. It is zero indicating that there is no delay at all from input to output.
5. The computation time for the low-pass filter is generally longer than the time required for the sum of the rest of the computations done by the ODATA math function. This is because the low-pass filter is a finite impulse response filter (emulating the shape of a 6th order Bessel filter). It can require hundreds of multiplies-and-adds per sample in the waveform. The higher the sample rate relative to the bit time, T, the longer the FIR is. It is adequate to sample at 10 to 20 times the channel bit time, T. For 1x DVD, T is 26.16 MHz. Twenty times that is 523 MHz, so 500 MS/s is a good sample rate.
6. The three-tap EQ filter uses as input the point to be replaced and the points 2T away on each side. Since 2T may not correspond to an integer number of scope samples, linear interpolation between scope samples is used to get the values at exactly 2T away on each side.

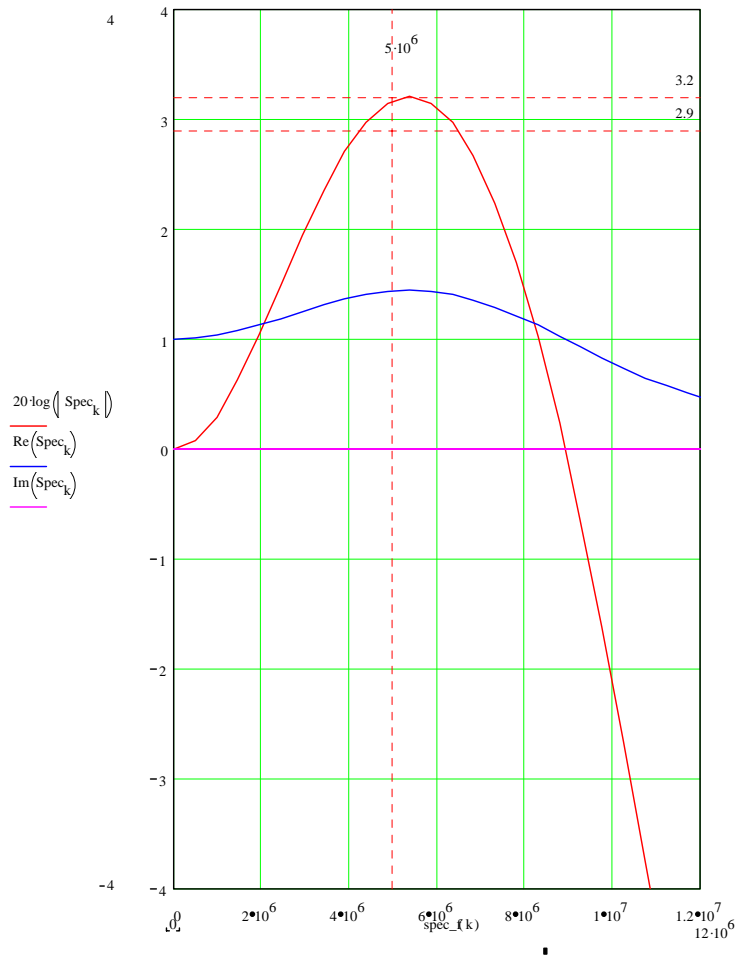

Simulation result showing transfer function of the digital low-pass filter and 3-tap EQ (boost) filter, set to 8.2 MHz cutoff frequency and 3.2 dB boost.

Leveled

There are no additional conditions to produce leveled data. The threshold is calculated and subtracted even if the equalization could not be applied for the reasons described above.

Extract Clk

It is usually not possible to get data and clock signals correctly aligned from an optical drive to visualize how the data edges align with the clock; in some cases, the clock may not be available at all. This function produces a clock waveform from the data by passing it through a software PLL. This output may be overlapped on the display with Leveled or Sliced output on another

trace; and it can be used for measurements of the clock frequency. If the JTA option is present, a JitterTrack of Frequency of the extracted clock may give interesting insight into timing variation in the input signal.

The only user-set parameter for clock extraction is the "PLL BW" setting on the "Equalizer and PLL" dialog. The PLL Bandwidth is the unity gain intercept of the open-loop transfer function of the PLL. The closed loop -3 dB frequency is approximately 1.274 time that. The loop filter meets the specification shown in Annex H of the DVD Physical specifications (or Annex G of the DVD-R Physical specifications). For 1x DVD the PLL BW should be set to 9 kHz. In that case the software PLL has this closed-loop response:

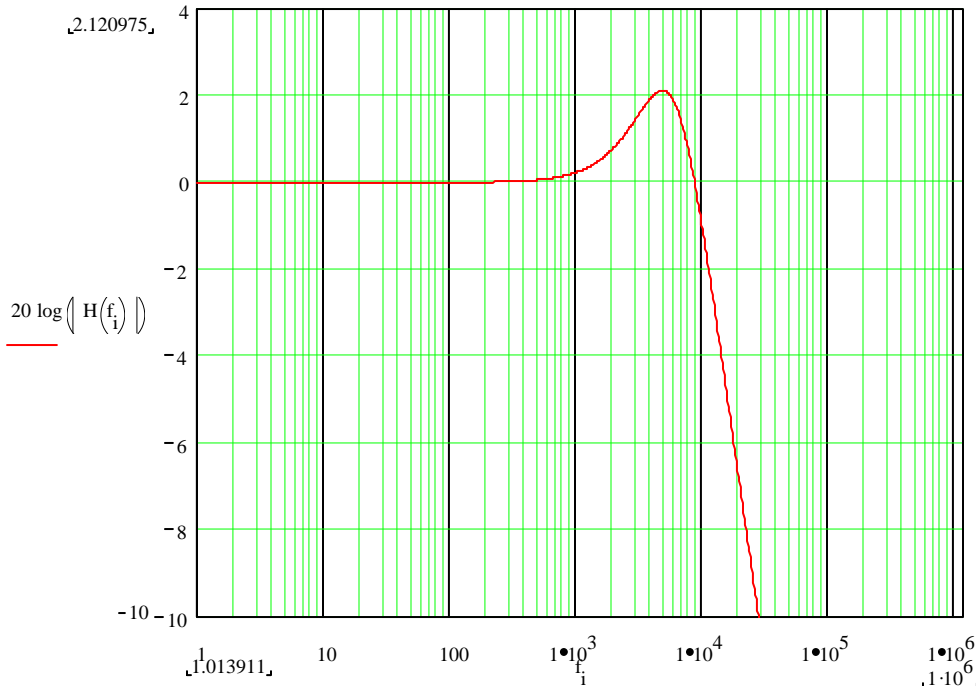

PLL closed-loop transfer function when "PLL BW" is set to 9 kHz.

The bandwidth of any PLL is a trade-off between jitter (phase noise) and desirable properties like a wide locking range and fast tracking. The "lock range" is the maximum frequency step for which the PLL can acquire lock without slipping a cycle. If we set up the VCO to start at other than the correct frequency (which corresponds to a frequency step), the PLL must change frequency to match the data. With PLL BW set to 9 kHz, the lock range is only about 25 kHz, slightly less than 0.1% of the expected clock frequency. The pull-in range is much broader but the pull-in time can be quite long. If we start the VCO just 0.4% away from the correct frequency, it would take hundreds of microseconds for the PLL to lock.

Since the acquired data may be a millisecond or less in duration, extracting the clock depends critically on the scope's ability to determine T ($1/\text{clock frequency}$) from the data and on starting the PLL's VCO at that frequency and at about the right phase. When it can do that, the VCO starts up locked and does not have to settle noticeably. If it cannot find the frequency, the warning message: "ORDATA VCO start freq is $3.19 * LP \text{ fc}$, didn't find it" will be displayed. As the message says, if the scope cannot find the frequency, it starts the VCO at $3.19024 * LP \text{ fc}$. That ratio is $26.16/8.2$ (to six significant digits). That is correct for DVD according to the specification; however, it may not be within 0.1% for a real drive. Experience shows that drives read a couple of percent fast.

To make the clock extraction successful, the scope must be successful in finding the starting frequency from the data. Here are some things you should do to make this successful:

1. Capture as clean a signal as possible. Remember that a passive probe is $10 \text{ M}\Omega$ resistive only at low frequencies and, therefore, may significantly load a high-speed signal. A passive probe's response will roll off well below the scope's DC $50 \text{ }\Omega$ bandwidth. Consider using a differential probe such as the AP033 or AP034, or an FET probe such as the AP020. Remember to attach the ground lead.
2. Equalize properly. If the signal you are probing is already equalized but not very clean, you can tell ODATA that it is RF anyway and set the boost to zero. That way the data will be low-pass filtered, which greatly reduces noise. If you don't equalize when you need to, or if you apply boost to an already equalized signal, the scope will probably not be able to determine the starting VCO frequency from the data, you will see the warning described above, and the extracted clock may not be good.
3. Sample at about 20 times the expected clock frequency. If you sample closer to 10 times the clock or below that, the extraction algorithm may not be able to correctly separate the peaks in the width distribution to determine the frequency at which to start the PLL. If you sample much more than 20 times the clock, the widths (in samples) may be too spread out from detectable peaks in the distribution. (See the following explanation "How the Starting VCO Frequency is Determined" for more details.) Example: CD data has $T = 231 \text{ ns}$, about 4.33 MHz . We can extract the clock from CD data at 100 MS/s (23x) and 200 MS/s (46x) or 250 MS/s (58x). At 50 MS/s (11.5x) and at 500 MS/s (115x), it sometimes does not find the right starting frequency. Another example: DVD has $T = 1/26.16 \text{ MHz}$, about 38.2 ns . We can extract the clock from DVD data at 500 MS/s (19x), 1 GS/s (38x), and 2 GS/s (76x). At 250 MS/s (9.5x) and at 4 GS/s (153x), it sometimes does not find the right starting frequency.

Following are some interesting pictures to show what can be handled:

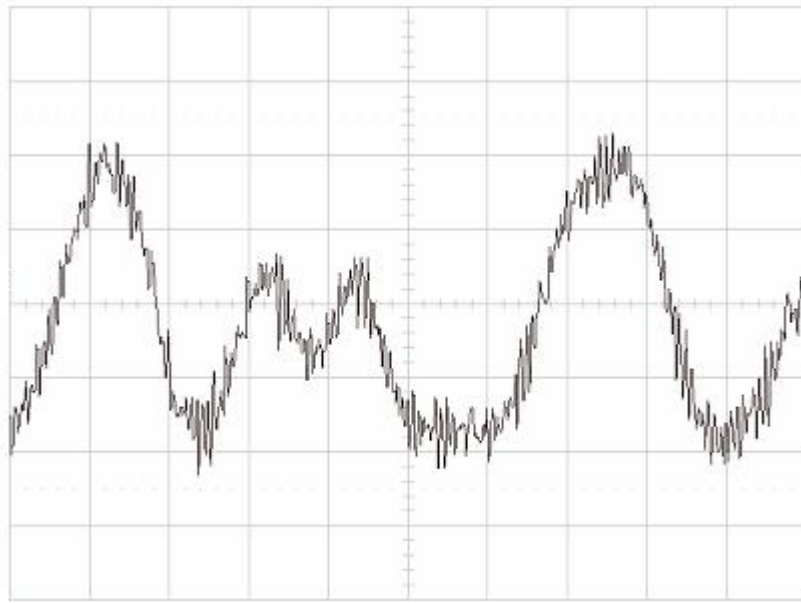

A small section of a 1 ms long noisy DVD waveform. Acquired with an ungrounded AP020 probe at 500 MS/s.

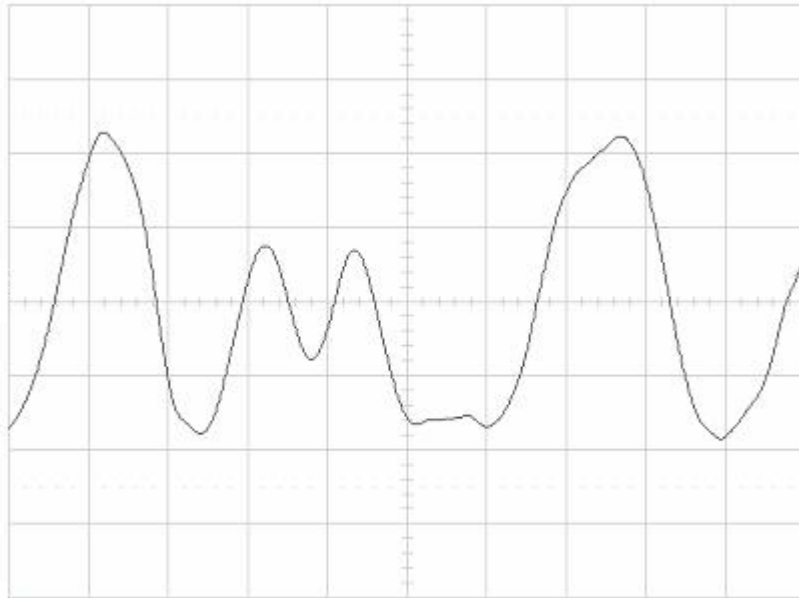

Same piece of the same signal, equalized and leveled.

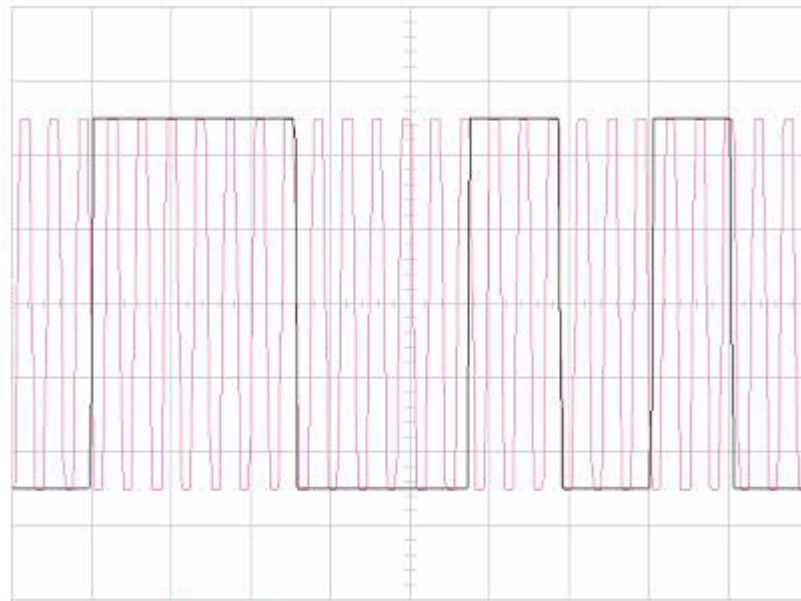

It should be mentioned that the extracted clock output is also exactly five divisions high (without vertical zoom), and its edges are linear from -0.1 to $+0.1 * T$ and from $+0.4$ to $+0.6 * T$. Therefore, if there are 20 samples per T , each edge of the extracted clock signal has four samples between the top and base. These samples are placed proportional to phase, so that the edge crosses 0 at exactly 0 and 180 degrees VCO phase.

Roughly, the phase steering target for the VCO is that the data transitions should happen on the falling edge of the VCO output. To be more precise, we steer such that the VCO phase will be 180 degrees at the sample where a zero crossing in the data is detected. Because the software VCO works on a sample-by-sample basis, there is, on average, a half-sample delay from the VCO falling edge's zero cross to the data zero cross. At 20 samples per T, this half-sample error is 2.5% of T, not noticeable without zooming in. At 10 samples per T, it is 5% of T. The following small figure shows part of a zoom on a rising data edge and a falling clock edge sampled at 500 MS/s (2 ns per sample). The horizontal scale is 2 ns per division. The samples are bold. Note that the data crosses zero at 1 ns after the falling edge of the VCO output crosses zero. This is the expected result.



The signal used is a 4.36 MHz square wave, which has a transition every 3T when $1/T = 26.16$ MHz. During the first 50 μ s or so the phase settles in from initial startup, after that all the zero crossings are half a sample apart, as shown in this picture.

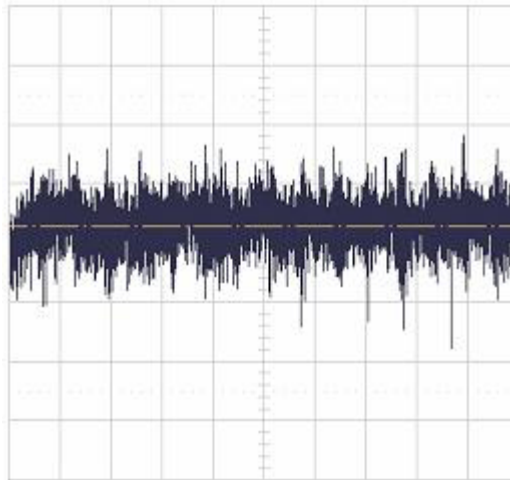

JitterTrack of Frequency (requires JTA option) of the extracted clock. The startup frequency was correct to within a few kHz, and the PLL did not slip. It is possible that the starting frequency was precise but the starting phase was not; the effect would be the same. JitterTrack shows frequency as a function of time. The vertical scale is 20 kHz per division; the cursor is positioned at 27.107 MHz. The horizontal scale is 0.1 ms per division.

How the Starting VCO Frequency and Phase are Determined

The PLL's VCO is started at a frequency of $1/T$. Due to the accuracy required, T is determined in two steps. The first step produces an estimate of T starting with very few assumptions. The second step starts with the estimate of T and refines it. The information used in both steps is the sample at which a transition (through zero) occurred in the sliced data, for up to the first 2000

edges. If the source waveform has less than 2000 edges, the accuracy of this procedure may be reduced.

If the source waveform has less than 50 edges, the instrument does not even attempt to estimate T. The PLL will start at $3.19024 * LP\text{ fc}$. Because of the low bandwidth of the PLL, it does not make much sense to try to extract the clock from a very short waveform; the PLL will not have time to react.

The first step calculates the width of the first (up to) 2000 pulses, sorts the widths, and finds the first three peaks in the distribution of widths. The distribution is "smoothed" by a five-bin wide boxcar filter to prevent small local events from misleading the peak detection. This is the primary reason why the signal must be over-sampled by greater than 10x. The distribution of widths is similar to a histogram of pwid (pit width) on "leveled" output of the ODATA function, using a threshold of 0.0 mV and measuring All widths. The spacing between the peaks is approximately T, close enough to determine the lowest nT. The instrument calculates the estimate of T from the means of the first three peaks, which are assumed to be lowest n, lowest n + 1, and lowest n + 2 (i.e., 3T, 4T, and 5T). This estimate is generally good to better than 1%.

The second step uses the location of the first (up to 2000) transitions, in order. It uses the estimate of T to calculate n between each pair of same-polarity edges. If the estimate is within 1%, we have at least 50% margin. A 50% margin occurs if a pair of same-polarity edges is 25T apart. On a good waveform, the count is likely to be exact. On a noisy or distorted waveform, it may be that some peaks are miscounted, but as long as some are long and some are short, the final total will be nearly correct. Finally, T is computed as:

$$(\text{time at the last transition} - \text{time at the first transition}) / (\text{total } n \text{ between them})$$

If there are 2000 edges, an average of 4T apart, the separation between first and last edge is 8000T. If our count of n is off by 1, that is a 0.0125% error. We can tolerate up to 7 counts error (0.0875%) before the PLL will not start locked. When the waveform is correctly equalized, this does not happen.

A highly asymmetric waveform will not have clean peaks in the distribution of its pulse widths, which also means that many of the pulses will be nearly $(n + 0.5)T$. On such a waveform, we may not be able to determine T. The possible reasons for failing to determine T (and therefore the VCO start frequency) are:

- Less than 50 edges in the waveform.
- Could not distinguish the first three peaks in the distribution of widths.

As mentioned above, you should sample at about 20x to 50x the clock frequency to make clock extraction work reliably.

An attempt is made to start the VCO not only at the correct frequency but also at the correct phase. The phase is pre-set such that the first edge in the waveform will occur on a falling edge of the VCO output. The first edge is just as likely to be out of place as any other edge in the waveform, of course. If the VCO starts significantly at the wrong phase it will either slow down or speed up for a short while until it gets to the right phase. A JitterTrack shows this clearly. On a 4x DVD waveform we captured, which just happens to have a significantly out-of-place first edge,



the frequency is disturbed slightly for the first 15 μ s or so; the frequency shift during this time is very small, on the order of 0.1%, as the phase adjusts.

§ § §



700 Chestnut Ridge Road
Chestnut Ridge, NY 10977
USA

teledynelecroy.com